



## **Catalyst 6500 Series Supervisor Engine Guide**

July 2011

### **Americas Headquarters**

Cisco Systems, Inc.  
170 West Tasman Drive  
San Jose, CA 95134-1706  
USA  
<http://www.cisco.com>  
Tel: 408 526-4000  
800 553-NETS (6387)  
Fax: 408 527-0883

Text Part Number: OL-7397-03

THE SPECIFICATIONS AND INFORMATION REGARDING THE PRODUCTS IN THIS MANUAL ARE SUBJECT TO CHANGE WITHOUT NOTICE. ALL STATEMENTS, INFORMATION, AND RECOMMENDATIONS IN THIS MANUAL ARE BELIEVED TO BE ACCURATE BUT ARE PRESENTED WITHOUT WARRANTY OF ANY KIND, EXPRESS OR IMPLIED. USERS MUST TAKE FULL RESPONSIBILITY FOR THEIR APPLICATION OF ANY PRODUCTS.

THE SOFTWARE LICENSE AND LIMITED WARRANTY FOR THE ACCOMPANYING PRODUCT ARE SET FORTH IN THE INFORMATION PACKET THAT SHIPPED WITH THE PRODUCT AND ARE INCORPORATED HEREIN BY THIS REFERENCE. IF YOU ARE UNABLE TO LOCATE THE SOFTWARE LICENSE OR LIMITED WARRANTY, CONTACT YOUR CISCO REPRESENTATIVE FOR A COPY.

The following information is for FCC compliance of Class A devices: This equipment has been tested and found to comply with the limits for a Class A digital device, pursuant to part 15 of the FCC rules. These limits are designed to provide reasonable protection against harmful interference when the equipment is operated in a commercial environment. This equipment generates, uses, and can radiate radio-frequency energy and, if not installed and used in accordance with the instruction manual, may cause harmful interference to radio communications. Operation of this equipment in a residential area is likely to cause harmful interference, in which case users will be required to correct the interference at their own expense.

The following information is for FCC compliance of Class B devices: The equipment described in this manual generates and may radiate radio-frequency energy. If it is not installed in accordance with Cisco's installation instructions, it may cause interference with radio and television reception. This equipment has been tested and found to comply with the limits for a Class B digital device in accordance with the specifications in part 15 of the FCC rules. These specifications are designed to provide reasonable protection against such interference in a residential installation. However, there is no guarantee that interference will not occur in a particular installation.

Modifying the equipment without Cisco's written authorization may result in the equipment no longer complying with FCC requirements for Class A or Class B digital devices. In that event, your right to use the equipment may be limited by FCC regulations, and you may be required to correct any interference to radio or television communications at your own expense.

You can determine whether your equipment is causing interference by turning it off. If the interference stops, it was probably caused by the Cisco equipment or one of its peripheral devices. If the equipment causes interference to radio or television reception, try to correct the interference by using one or more of the following measures:

- Turn the television or radio antenna until the interference stops.
- Move the equipment to one side or the other of the television or radio.
- Move the equipment farther away from the television or radio.
- Plug the equipment into an outlet that is on a different circuit from the television or radio. (That is, make certain the equipment and the television or radio are on circuits controlled by different circuit breakers or fuses.)

Modifications to this product not authorized by Cisco Systems, Inc. could void the FCC approval and negate your authority to operate the product.

The Cisco implementation of TCP header compression is an adaptation of a program developed by the University of California, Berkeley (UCB) as part of UCB's public domain version of the UNIX operating system. All rights reserved. Copyright © 1981, Regents of the University of California.

NOTWITHSTANDING ANY OTHER WARRANTY HEREIN, ALL DOCUMENT FILES AND SOFTWARE OF THESE SUPPLIERS ARE PROVIDED "AS IS" WITH ALL FAULTS. CISCO AND THE ABOVE-NAMED SUPPLIERS DISCLAIM ALL WARRANTIES, EXPRESSED OR IMPLIED, INCLUDING, WITHOUT LIMITATION, THOSE OF MERCHANTABILITY, FITNESS FOR A PARTICULAR PURPOSE AND NONINFRINGEMENT OR ARISING FROM A COURSE OF DEALING, USAGE, OR TRADE PRACTICE.

IN NO EVENT SHALL CISCO OR ITS SUPPLIERS BE LIABLE FOR ANY INDIRECT, SPECIAL, CONSEQUENTIAL, OR INCIDENTAL DAMAGES, INCLUDING, WITHOUT LIMITATION, LOST PROFITS OR LOSS OR DAMAGE TO DATA ARISING OUT OF THE USE OR INABILITY TO USE THIS MANUAL, EVEN IF CISCO OR ITS SUPPLIERS HAVE BEEN ADVISED OF THE POSSIBILITY OF SUCH DAMAGES.

Cisco and the Cisco Logo are trademarks of Cisco Systems, Inc. and/or its affiliates in the U.S. and other countries. A listing of Cisco's trademarks can be found at [www.cisco.com/go/trademarks](http://www.cisco.com/go/trademarks). Third party trademarks mentioned are the property of their respective owners. The use of the word partner does not imply a partnership relationship between Cisco and any other company. (1005R)

*Catalyst 6500 Series Supervisor Engine Guide*  
Copyright © 1999–2011 Cisco Systems, Inc. All rights reserved.



# CONTENTS

## **Preface** v

Audience v

Organization v

Conventions vi

Statement 1071—Warning Definition vii

Related Documentation xiii

---

## **CHAPTER 1**

### **Catalyst 6500 Series Switch Chassis Overview** 1-1

Catalyst 6503 Switch 1-1

Catalyst 6503-E 1-2

Catalyst 6504-E 1-3

Catalyst 6506 1-4

Catalyst 6506-E 1-5

Catalyst 6509 1-6

Catalyst 6509-E 1-7

Catalyst 6509-NEB 1-8

Catalyst 6509-NEB-A 1-9

Catalyst 6509-V-E 1-10

Catalyst 6513 1-11

Catalyst 6513-E 1-12

---

## **CHAPTER 2**

### **Supervisor Engines** 2-1

Supervisor Engine 2 2-1

Supervisor Engine 32 2-7

Supervisor Engine 32 PISA 2-14

Supervisor Engine 720 2-21

Supervisor Engine 720-10GE 2-26

Supervisor Engine 2T 2-33

**CHAPTER 3**

**Installing Supervisor Engines 3-1**

- Safety 3-1
- Required Tools 3-2
- Installing a Supervisor Engine 3-2
- Removing a Supervisor Engine 3-10
- USB Console Port Driver Installation 3-13
  - Installing the Cisco Microsoft Windows USB Device Driver 3-13
  - Uninstalling the Cisco Microsoft Windows USB Driver 3-15
- Installing Pluggable Transceivers 3-17
- Attaching the Network Interface Cables 3-17
  - Attaching Optical Network Interface Cables 3-18
  - Mode-Conditioning Patch Cord 3-18
  - Connecting Transceivers to a Copper Network 3-22
- Where to Go Next 3-22

**APPENDIX A**

**Pluggable Transceivers A-1**

**APPENDIX B**

**Port, Cable, and Connector Specifications B-1**

- Console Port B-1
  - Console Port Cables and Adapters B-1
  - CONSOLE PORT MODE Switch (Supervisor Engine 2 Only) B-2
  - Console Port Mode 2 Signaling and Pinouts B-5
- Uplink Ports B-5
- USB Ports B-7
- Copper and Fiber-Optic Connectors B-7
  - RJ-45 Connector B-7
  - Fiber-Optic Connectors B-8

**APPENDIX C**

**ESD Precautions C-1**

- Attaching Your ESD Grounding Strap C-1

**INDEX**



## Preface

---

This preface describes who should read the *Catalyst 6500 Series Supervisor Engine Guide*, how it is organized, and its document conventions.

## Audience

Only trained and qualified service personnel (as defined in IEC 60950 and AS/NZS3260) should install, replace, or service the equipment described in this publication.

## Organization

This publication is organized as follows:

Chapter	Title	Description
Chapter 1	<a href="#">Catalyst 6500 Series Switch Chassis Overview</a>	Provides an overview of the Catalyst 6500 series switches.
Chapter 2	<a href="#">Supervisor Engines</a>	Describes the Catalyst 6500 series supervisor engines.
Chapter 3	<a href="#">Installing Supervisor Engines</a>	Describes how to correctly and safely install supervisor engines in the chassis.
Appendix A	<a href="#">Pluggable Transceivers</a>	Provides information on the pluggable transceivers supported by the supervisor engines.
Appendix B	<a href="#">Port, Cable, and Connector Specifications</a>	Lists the cable specifications for the Catalyst 6500 series supervisor engine ports.
Appendix C	<a href="#">ESD Precautions</a>	Describes ESD safety precautions that you need to follow when handling the supervisor engines.

# Conventions

This publication uses the following conventions:

Convention	Description
<b>boldface</b> font	Commands, command options, and keywords are in <b>boldface</b> .
<i>italic</i> font	Arguments for which you supply values are in <i>italics</i> .
[ ]	Elements in square brackets are optional.
{ x   y   z }	Alternative keywords are grouped in braces and separated by vertical bars.
[ x   y   z ]	Optional alternative keywords are grouped in brackets and separated by vertical bars.
string	A nonquoted set of characters. Do not use quotation marks around the string or the string will include the quotation marks.
screen font	Terminal sessions and information the system displays are in screen font.
<b>boldface screen font</b>	Information you must enter is in <b>boldface screen font</b> .
<i>italic screen font</i>	Arguments for which you supply values are in <i>italic screen font</i> .
^	The symbol ^ represents the key labeled Control. For example, the key combination ^D in a screen display means hold down the Control key while you press the D key.
< >	Nonprinting characters, such as passwords, are in angle brackets.

Notes use the following conventions:



## Note

Means *reader take note*. Notes contain helpful suggestions or references to material not covered in the publication.

Cautions use the following conventions:



## Caution

Means *reader be careful*. In this situation, you might do something that could result in equipment damage or loss of data.

Warnings use the following conventions:

## Statement 1071—Warning Definition



Warning

### IMPORTANT SAFETY INSTRUCTIONS

This warning symbol means danger. You are in a situation that could cause bodily injury. Before you work on any equipment, be aware of the hazards involved with electrical circuitry and be familiar with standard practices for preventing accidents. Use the statement number provided at the end of each warning to locate its translation in the translated safety warnings that accompanied this device. Statement 1071

### SAVE THESE INSTRUCTIONS

Waarschuwing

### BELANGRIJKE VEILIGHEIDSINSTRUCTIES

Dit waarschuwingssymbool betekent gevaar. U verkeert in een situatie die lichamelijk letsel kan veroorzaken. Voordat u aan enige apparatuur gaat werken, dient u zich bewust te zijn van de bij elektrische schakelingen betrokken risico's en dient u op de hoogte te zijn van de standaard praktijken om ongelukken te voorkomen. Gebruik het nummer van de verklaring onderaan de waarschuwing als u een vertaling van de waarschuwing die bij het apparaat wordt geleverd, wilt raadplegen.

### BEWAAR DEZE INSTRUCTIES

Varoitus

### TÄRKEITÄ TURVALLISUUSOHJEITA

Tämä varoitusmerkki merkitsee vaaraa. Tilanne voi aiheuttaa ruumiillisia vammoja. Ennen kuin käsittelet laitteistoa, huomioi sähköpiirien käsittelyyn liittyvät riskit ja tutustu onnettomuuksien yleisiin ehkäisytapoihin. Turvallisuusvaroitusten käännökset löytyvät laitteen mukana toimitettujen käännettyjen turvallisuusvaroitusten joukosta varoitusten lopussa näkyvien lausuntonumeroiden avulla.

### SÄILYTÄ NÄMÄ OHJEET

Attention

### IMPORTANTES INFORMATIONS DE SÉCURITÉ

Ce symbole d'avertissement indique un danger. Vous vous trouvez dans une situation pouvant entraîner des blessures ou des dommages corporels. Avant de travailler sur un équipement, soyez conscient des dangers liés aux circuits électriques et familiarisez-vous avec les procédures couramment utilisées pour éviter les accidents. Pour prendre connaissance des traductions des avertissements figurant dans les consignes de sécurité traduites qui accompagnent cet appareil, référez-vous au numéro de l'instruction situé à la fin de chaque avertissement.

### CONSERVEZ CES INFORMATIONS

**Warnung WICHTIGE SICHERHEITSHINWEISE**

Dieses Warnsymbol bedeutet Gefahr. Sie befinden sich in einer Situation, die zu Verletzungen führen kann. Machen Sie sich vor der Arbeit mit Geräten mit den Gefahren elektrischer Schaltungen und den üblichen Verfahren zur Vorbeugung vor Unfällen vertraut. Suchen Sie mit der am Ende jeder Warnung angegebenen Anweisungsnummer nach der jeweiligen Übersetzung in den übersetzten Sicherheitshinweisen, die zusammen mit diesem Gerät ausgeliefert wurden.

**BEWAHREN SIE DIESE HINWEISE GUT AUF.**

**Avvertenza IMPORTANTI ISTRUZIONI SULLA SICUREZZA**

Questo simbolo di avvertenza indica un pericolo. La situazione potrebbe causare infortuni alle persone. Prima di intervenire su qualsiasi apparecchiatura, occorre essere al corrente dei pericoli relativi ai circuiti elettrici e conoscere le procedure standard per la prevenzione di incidenti. Utilizzare il numero di istruzione presente alla fine di ciascuna avvertenza per individuare le traduzioni delle avvertenze riportate in questo documento.

**CONSERVARE QUESTE ISTRUZIONI**

**Advarsel VIKTIGE SIKKERHETSINSTRUKSJONER**

Dette advarselssymbolet betyr fare. Du er i en situasjon som kan føre til skade på person. Før du begynner å arbeide med noe av utstyret, må du være oppmerksom på farene forbundet med elektriske kretser, og kjenne til standardprosedyrer for å forhindre ulykker. Bruk nummeret i slutten av hver advarsel for å finne oversettelsen i de oversatte sikkerhetsadvarslene som fulgte med denne enheten.

**TA VARE PÅ DISSE INSTRUKSJONENE**

**Aviso INSTRUÇÕES IMPORTANTES DE SEGURANÇA**

Este símbolo de aviso significa perigo. Você está em uma situação que poderá ser causadora de lesões corporais. Antes de iniciar a utilização de qualquer equipamento, tenha conhecimento dos perigos envolvidos no manuseio de circuitos elétricos e familiarize-se com as práticas habituais de prevenção de acidentes. Utilize o número da instrução fornecido ao final de cada aviso para localizar sua tradução nos avisos de segurança traduzidos que acompanham este dispositivo.

**GUARDE ESTAS INSTRUÇÕES**

**¡Advertencia! INSTRUCCIONES IMPORTANTES DE SEGURIDAD**

Este símbolo de aviso indica peligro. Existe riesgo para su integridad física. Antes de manipular cualquier equipo, considere los riesgos de la corriente eléctrica y familiarícese con los procedimientos estándar de prevención de accidentes. Al final de cada advertencia encontrará el número que le ayudará a encontrar el texto traducido en el apartado de traducciones que acompaña a este dispositivo.

**GUARDE ESTAS INSTRUCCIONES**



**Varning! VIKTIGA SÄKERHETSANVISNINGAR**

Denna varningssignal signalerar fara. Du befinner dig i en situation som kan leda till personskada. Innan du utför arbete på någon utrustning måste du vara medveten om farorna med elkretsar och känna till vanliga förfaranden för att förebygga olyckor. Använd det nummer som finns i slutet av varje varning för att hitta dess översättning i de översatta säkerhetsvarningar som medföljer denna anordning.

**SPARA DESSA ANVISNINGAR****Figyelem FONTOS BIZTONSÁGI ELOÍRÁSOK**

Ez a figyelmeztető jel veszélyre utal. Sérülésveszélyt rejtő helyzetben van. Mielőtt bármely berendezésen munkát végezte, legyen figyelemmel az elektromos áramkörök okozta kockázatokra, és ismerkedjen meg a szokásos balesetvédelmi eljárásokkal. A kiadványban szereplő figyelmeztetések fordítása a készülékhez mellékelt biztonsági figyelmeztetések között található; a fordítás az egyes figyelmeztetések végén látható szám alapján kereshető meg.

**ORIZZE MEG EZEKET AZ UTASÍTÁSOKAT!****Предупреждение ВАЖНЫЕ ИНСТРУКЦИИ ПО СОБЛЮДЕНИЮ ТЕХНИКИ БЕЗОПАСНОСТИ**

Этот символ предупреждения обозначает опасность. То есть имеет место ситуация, в которой следует опасаться телесных повреждений. Перед эксплуатацией оборудования выясните, каким опасностям может подвергаться пользователь при использовании электрических цепей, и ознакомьтесь с правилами техники безопасности для предотвращения возможных несчастных случаев. Воспользуйтесь номером заявления, приведенным в конце каждого предупреждения, чтобы найти его переведенный вариант в переводе предупреждений по безопасности, прилагаемом к данному устройству.

**СОХРАНИТЕ ЭТИ ИНСТРУКЦИИ****警告 重要的安全性说明**

此警告符号代表危险。您正处于可能受到严重伤害的工作环境中。在您使用设备开始工作之前，必须充分意识到触电的危险，并熟练掌握防止事故发生的标准工作程序。请根据每项警告结尾提供的声明号码来找到此设备的安全性警告说明的翻译文本。

请保存这些安全性说明

**警告 安全上の重要な注意事項**

「危険」の意味です。人身事故を予防するための注意事項が記述されています。装置の取り扱い作業を行うときは、電気回路の危険性に注意し、一般的な事故防止策に留意してください。警告の各国語版は、各注意事項の番号を基に、装置に付属の「Translated Safety Warnings」を参照してください。

これらの注意事項を保管しておいてください。

**주의**    **중요 안전 지침**

이 경고 기호는 위험을 나타냅니다. 작업자가 신체 부상을 일으킬 수 있는 위험한 환경에 있습니다. 장비에 작업을 수행하기 전에 전기 회로와 관련된 위험을 숙지하고 표준 작업 관례를 숙지하여 사고를 방지하십시오. 각 경고의 마지막 부분에 있는 경고문 번호를 참조하여 이 장치와 함께 제공되는 번역된 안전 경고문에서 해당 번역문을 찾으십시오.

이 지시 사항을 보관하십시오.

**Aviso**    **INSTRUÇÕES IMPORTANTES DE SEGURANÇA**

**Este símbolo de aviso significa perigo. Você se encontra em uma situação em que há risco de lesões corporais. Antes de trabalhar com qualquer equipamento, esteja ciente dos riscos que envolvem os circuitos elétricos e familiarize-se com as práticas padrão de prevenção de acidentes. Use o número da declaração fornecido ao final de cada aviso para localizar sua tradução nos avisos de segurança traduzidos que acompanham o dispositivo.**

**GUARDE ESTAS INSTRUÇÕES****Advarsel**    **VIGTIGE SIKKERHEDSANVISNINGER**

**Dette advarselssymbol betyder fare. Du befinder dig i en situation med risiko for legemeskadedigelse. Før du begynder arbejde på udstyr, skal du være opmærksom på de involverede risici, der er ved elektriske kredsløb, og du skal sætte dig ind i standardprocedurer til undgåelse af ulykker. Brug erklæringsnummeret efter hver advarsel for at finde oversættelsen i de oversatte advarsler, der fulgte med denne enhed.**

**GEM DISSE ANVISNINGER****تحذير****إرشادات الأمان الهامة**

يوضح رمز التحذير هذا وجود خطر. وهذا يعني أنك متواجد في مكان قد ينتج عنه التعرض لإصابات. قبل بدء العمل، احذر مخاطر التعرض للصدمة الكهربائية وكن على علم بالإجراءات القياسية للحيلولة دون وقوع أي حوادث. استخدم رقم البيان الموجود في آخر كل تحذير لتحديد مكان ترجمته داخل تحذيرات الأمان المترجمة التي تأتي مع الجهاز. قم بحفظ هذه الإرشادات

**Upozorenje**    **VAŽNE SIGURNOSNE NAPOMENE**

**Ovaj simbol upozorenja predstavlja opasnost. Nalazite se u situaciji koja može prouzročiti tjelesne ozljede. Prije rada s bilo kojim uređajem, morate razumjeti opasnosti vezane uz električne sklopove, te biti upoznati sa standardnim načinima izbjegavanja nesreća. U prevedenim sigurnosnim upozorenjima, priloženima uz uređaj, možete prema broju koji se nalazi uz pojedino upozorenje pronaći i njegov prijevod.**

**SAČUVAJTE OVE UPUTE**

**Upozornění DŮLEŽITÉ BEZPEČNOSTNÍ POKYNY**

Tento upozorňující symbol označuje nebezpečí. Jste v situaci, která by mohla způsobit nebezpečí úrazu. Před prací na jakémkoliv vybavení si uvědomte nebezpečí související s elektrickými obvody a seznamte se se standardními opatřeními pro předcházení úrazům. Podle čísla na konci každého upozornění vyhledejte jeho překlad v přeložených bezpečnostních upozorněních, která jsou přiložena k zařízení.

**USCHOVEJTE TYTO POKYNY****Προειδοποίηση ΣΗΜΑΝΤΙΚΕΣ ΟΔΗΓΙΕΣ ΑΣΦΑΛΕΙΑΣ**

Αυτό το προειδοποιητικό σύμβολο σημαίνει κίνδυνο. Βρίσκεστε σε κατάσταση που μπορεί να προκαλέσει τραυματισμό. Πριν εργαστείτε σε οποιοδήποτε εξοπλισμό, να έχετε υπόψη σας τους κινδύνους που σχετίζονται με τα ηλεκτρικά κυκλώματα και να έχετε εξοικειωθεί με τις συνήθεις πρακτικές για την αποφυγή ατυχημάτων. Χρησιμοποιήστε τον αριθμό δήλωσης που παρέχεται στο τέλος κάθε προειδοποίησης, για να εντοπίσετε τη μετάφρασή της στις μεταφρασμένες προειδοποιήσεις ασφαλείας που συνοδεύουν τη συσκευή.

**ΦΥΛΑΞΤΕ ΑΥΤΕΣ ΤΙΣ ΟΔΗΓΙΕΣ**

הרהר

**Opomena ВАЖНИ БЕЗБЕДНОСНИ НАПАТСТВИЈА**

Симболот за предупредување значи опасност. Се наоѓате во ситуација што може да предизвика телесни повреди. Пред да работите со опремата, бидете свесни за ризикот што постои кај електричните кола и треба да ги познавате стандардните постапки за спречување на несреќни случаи. Искористете го бројот на изјавата што се наоѓа на крајот на секое предупредување за да го најдете неговиот период во преведените безбедносни предупредувања што се испорачани со уредот.  
ЧУВАЈТЕ ГИ ОБИЕ НАПАТСТВИЈА

**Ostrzeżenie WAŻNE INSTRUKCJE DOTYCZĄCE BEZPIECZEŃSTWA**

Ten symbol ostrzeżenia oznacza niebezpieczeństwo. Zachodzi sytuacja, która może powodować obrażenia ciała. Przed przystąpieniem do prac przy urządzeniach należy zapoznać się z zagrożeniami związanymi z układami elektrycznymi oraz ze standardowymi środkami zapobiegania wypadkom. Na końcu każdego ostrzeżenia podano numer, na podstawie którego można odszukać tłumaczenie tego ostrzeżenia w dołączonym do urządzenia dokumencie z tłumaczeniami ostrzeżeń.

**NINIEJSZE INSTRUKCJE NALEŻY ZACHOWAĆ**

**Upozornenie DŔLEŽITÉ BEZPEČNOSTNÉ POKYNY**

Tento varovný symbol označuje nebezpečenstvo. Nachádzate sa v situácii s nebezpečenstvom úrazu. Pred prácou na akomkoľvek vybavení si uvedomte nebezpečenstvo súvisiace s elektrickými obvodmi a oboznámte sa so štandardnými opatreniami na predchádzanie úrazom. Podľa čísla na konci každého upozornenia vyhľadajte jeho preklad v preložených bezpečnostných upozorneniach, ktoré sú priložené k zariadeniu.

**USCHOVAJTE SI TENTO NÁVOD****Opozorilo POMEMBNI VARNOSTNI NAPOTKI**

Ta opozorilni simbol pomeni nevarnost. Nahajate se v situaciji, kjer lahko pride do telesnih poškodb. Preden pričnete z delom na napravi, se morate zavedati nevarnosti udara električnega toka, ter tudi poznati preventivne ukrepe za preprečevanje takšnih nevarnosti. Uporabite obrazložitevno številko na koncu posameznega opozorila, da najdete opis nevarnosti v priloženem varnostnem priročniku.

**SHRANITE TE NAPOTKE!****警告****重要安全性指示**

此警告符號代表危險，表示可能造成人身傷害。使用任何設備前，請留心電路相關危險，並熟悉避免意外的標準作法。您可以使用每項警告後的聲明編號，查詢本裝置隨附之安全性警告譯文中的翻譯。請妥善保留此指示

## Related Documentation

For instructions on installing and configuring Catalyst 6500 series switches, refer to these publications:

- *Regulatory Compliance and Safety Information for the Catalyst 6500 Series Switches*
- *Catalyst 6500 Series Module Guide*
- *Catalyst 6500 Series Switch Quick Software Configuration Guide*
- *Catalyst 6500 Series Switch Installation Guide*
- *Catalyst 6500 Series Switch Software Configuration Guide*
- *Catalyst 6500 Series Switch Command Reference*
- *Catalyst 6500 Series Switch Cisco IOS Software Configuration Guide*
- *Catalyst 6500 Series Switch Cisco IOS Command Reference*
- *Catalyst 6500 Series System Message Guide*
- *Installation Note for the CWDM Passive Optical System*
- For information about MIBs, refer to the following World Wide Web site:  
<http://www.cisco.com/public/sw-center/netmgmt/cmtk/mibs.shtml>

## Obtaining Documentation and Submitting a Service Request

For information on obtaining documentation, submitting a service request, and gathering additional information, see the monthly *What's New in Cisco Product Documentation*, which also lists all new and revised Cisco technical documentation, at:

<http://www.cisco.com/en/US/docs/general/whatsnew/whatsnew.html>

Subscribe to the *What's New in Cisco Product Documentation* as a Really Simple Syndication (RSS) feed and set content to be delivered directly to your desktop using a reader application. The RSS feeds are a free service and Cisco currently supports RSS version 2.0.





# CHAPTER 1

## Catalyst 6500 Series Switch Chassis Overview

---

**Revised: July 2011**

This chapter provides a brief overview of the Catalyst 6500 series switches. For details on the individual Catalyst 6500 series chassis, see the information listed on this page:

[http://www.cisco.com/en/US/products/hw/switches/ps708/tsd\\_products\\_support\\_series\\_home.html](http://www.cisco.com/en/US/products/hw/switches/ps708/tsd_products_support_series_home.html)



**Note**

---

Throughout this publication, except where noted, the term *supervisor engine* is used to refer to Supervisor Engine 2, Supervisor Engine 32, Supervisor Engine 32 PISA, Supervisor Engine 720, Supervisor Engine 720-10GE, and the Supervisor Engine 2T.

---

### Catalyst 6503 Switch

The Catalyst 6503 switch is a 3-slot (numbered from (1) top to (3) bottom), 4 RU, horizontal chassis that supports redundant power supplies and redundant supervisor engines. The chassis is NEBS L3 compliant. Supervisor engine support includes:

- Supervisor Engine 2, Supervisor Engine 32, Supervisor Engine 32 PISA, and Supervisor Engine 720 are supported.

**Note** Refer to your software release notes for specific information on the minimum software release versions required to support the supervisor engines in the Catalyst 6503 chassis.

- Supervisor engines must be installed in chassis slot 1 or slot 2.

**Note** Slots not occupied by supervisor engines can be used for modules. Check your software release notes for any restrictions on the type of module that can be installed.

- Supervisor Engine 720 has a built-in switching fabric. Switch Fabric Modules (WS-C6500-SFM and WS-X6500-SFM2) are not supported by Supervisor Engine 720. The Switch Fabric Modules and Supervisor Engine 720 cannot be installed in the same chassis.
- Supervisor Engine 32 and Supervisor Engine 32 PISA do not support the Switch Fabric Modules (WS-C6500-SFM and WS-X6500-SFM2). The Switch Fabric Modules and the Supervisor Engine 32 or the Supervisor Engine 32 PISA cannot be installed in the same chassis.

- Supervisor Engine 32, Supervisor Engine 32 PISA, and the Supervisor Engine 720 require additional cooling. You must install the optional high-speed fan tray (FAN-MOD-3HS) in the chassis when any of these three supervisor engines are installed.
- The uplink ports are fully functional on the redundant supervisor engine when it is in standby mode.

**Note** In systems with redundant supervisor engines, both supervisor engines must be the same model and have the same daughter card configurations. Each supervisor engine must have the resources to run the switch on its own, which means that all supervisor engine resources are duplicated. Identical supervisor engine memory configurations are recommended but are not required as long as the supervisor engine with the smaller memory configuration is sufficient to run the configured features of the switch. Additionally, each supervisor engine must have its own flash device and console port connections.

Additional information on the Catalyst 6503 switch chassis including data sheets and chassis installation is located at:

[http://www.cisco.com/en/US/products/hw/switches/ps708/tsd\\_products\\_support\\_series\\_home.html](http://www.cisco.com/en/US/products/hw/switches/ps708/tsd_products_support_series_home.html)

## Catalyst 6503-E

The Catalyst 6503-E switch is an enhanced version of the Catalyst 6503 switch. The 3-slot (numbered from (1) top to (3) bottom), 4 RU, horizontal chassis supports redundant power supplies and redundant supervisor engines. It also supports a greater power capacity per slot than the Catalyst 6503 switch chassis and supports the WS-X67xx and WS-X68xx switching modules. The Catalyst 6503-E switch chassis is NEBS L3 compliant. Supervisor engine support and restrictions for the Catalyst 6503-E includes:

- Supervisor Engine 2, Supervisor Engine 32, Supervisor Engine 32 PISA, Supervisor Engine 720, Supervisor Engine 720-10GE, and Supervisor Engine 2T are supported.

**Note** Refer to your software release notes for specific information on the minimum software release versions required to support the supervisor engines in the Catalyst 6503-E chassis.

- Supervisor engines must be installed in slot 1 or slot 2.

**Note** Slots not occupied by supervisor engines can be used for modules. Check your software release notes for any restrictions on the type of module that can be installed.

- Supervisor Engine 720, Supervisor Engine 720-10GE, and Supervisor Engine 2T have a built-in switching fabric. The Switch Fabric Modules (WS-C6500-SFM and WS-X6500-SFM2) are not supported by Supervisor Engine 720 and Supervisor Engine 720-10GE and cannot be installed in the same chassis.



- Supervisor Engine 32 and Supervisor Engine 32 PISA do not support the Switch Fabric Modules (WS-C6500-SFM and WS-X6500-SFM2) and cannot be installed in the same chassis.
- The uplink ports are fully functional on the redundant supervisor engine when it is in standby mode.

**Note** In systems with redundant supervisor engines, both supervisor engines must be the same model and have the same daughter card configurations. Each supervisor engine must have the resources to run the switch on its own, which means that all supervisor engine resources are duplicated. Identical supervisor engine memory configurations are recommended but are not required as long as the supervisor engine with the smaller memory configuration is sufficient to run the configured features of the switch. Additionally, each supervisor engine must have its own flash device and console port connections.

Additional information on the Catalyst 6503-E switch chassis including data sheets and chassis installation is located at:

[http://www.cisco.com/en/US/products/hw/switches/ps708/tsd\\_products\\_support\\_series\\_home.html](http://www.cisco.com/en/US/products/hw/switches/ps708/tsd_products_support_series_home.html)

## Catalyst 6504-E

The Catalyst 6504-E switch is an enhanced 4-slot (numbered from (1) top to (4) bottom), 5 RU, horizontal chassis that supports redundant power supplies and redundant supervisor engines. The Catalyst 6504-E switch chassis is NEBS L3 compliant. Supervisor engine support and restrictions for the Catalyst 6504-E includes:

- Supervisor Engine 2, Supervisor Engine 32, Supervisor Engine 32 PISA, Supervisor Engine 720, Supervisor Engine 720-10GE, and the Supervisor Engine 2T are supported.

**Note** Refer to your software release notes for specific information on the minimum software release versions required to support the supervisor engines in the Catalyst 6504-E chassis.

- Supervisor engines must be installed in slot 1 or slot 2.

**Note** Slots not occupied by supervisor engines can be used for modules. Check your software release notes for any restrictions on the type of module that can be installed.

- Supervisor Engine 720, Supervisor Engine 720-10GE, and Supervisor Engine 2T have a built-in switching fabric. Switch Fabric Modules (WS-C6500-SFM and WS-X6500-SFM2) are not supported by Supervisor Engine 720, Supervisor Engine 720-10GE, and Supervisor Engine 2T and cannot be installed in the same chassis.

- Supervisor Engine 32 and Supervisor Engine 32 PISA do not support the Switch Fabric Modules (WS-C6500-SFM and WS-X6500-SFM2). The Switch Fabric Modules and Supervisor Engine 32 or Supervisor Engine 32 PISA cannot be installed in the same chassis.
- The uplink ports are fully functional on the redundant supervisor engine when it is in standby mode.

**Note** In systems with redundant supervisor engines, both supervisor engines must be the same model and have the same daughter card configurations. Each supervisor engine must have the resources to run the switch on its own, which means that all supervisor engine resources are duplicated. Identical supervisor engine memory configurations are recommended but are not required as long as the supervisor engine with the smaller memory configuration is sufficient to run the configured features of the switch. Additionally, each supervisor engine must have its own flash device and console port connections.

Additional information on the Catalyst 6504-E switch chassis including data sheets and chassis installation is located at:

[http://www.cisco.com/en/US/products/hw/switches/ps708/tsd\\_products\\_support\\_series\\_home.html](http://www.cisco.com/en/US/products/hw/switches/ps708/tsd_products_support_series_home.html)

## Catalyst 6506

The Catalyst 6506 switch is a 6-slot (numbered from (1) top to (6) bottom), 12 RU, horizontal chassis that supports redundant power supplies and redundant supervisor engines. The chassis is NEBS L3 compliant. Supervisor engine support and restrictions for the Catalyst 6506 includes:

- Supervisor Engine 2, Supervisor Engine 32, Supervisor Engine 32 PISA, Supervisor Engine 720, and Supervisor Engine 720-10GE are supported.

**Note** Refer to your software release notes for specific information on the minimum software release versions required to support the supervisor engines in the Catalyst 6506 chassis.

- Supervisor Engine 2 must be installed in slot 1 or slot 2.
- Supervisor Engine 32, Supervisor Engine 32 PISA, Supervisor Engine 720, and Supervisor Engine 720-10GE must be installed in slot 5 or slot 6.

**Note** Slots not occupied by supervisor engines can be used for modules. Check your software release notes for any restrictions on the type of module that can be installed.

- Supervisor Engine 32, Supervisor Engine 32 PISA, Supervisor Engine 720, and Supervisor Engine 720-10GE all require the high-speed fan tray (WS-C6K-6SLOT-FAN2) be installed in the chassis. You must also install a 2500 W or higher capacity power supply in the chassis to power the high-speed fan tray.

**Note** The 2500 W power supply, when supporting the high-speed fan tray, can be powered from either 120 VAC or 220 VAC.

- Supervisor Engine 720 and Supervisor Engine 720-10GE have a built-in switching fabric. Switch Fabric Modules (WS-C6500-SFM and WS-X6500-SFM2) are not supported by Supervisor Engine 720 and Supervisor Engine 720-10GE. The Switch Fabric Modules and Supervisor Engine 720 or Supervisor Engine 720-10GE cannot be installed in the same chassis.

- Supervisor Engine 32 and Supervisor Engine 32 PISA do not support the Switch Fabric Modules (WS-C6500-SFM and WS-X6500-SFM2). The Switch Fabric Modules and Supervisor Engine 32 or Supervisor Engine 32 PISA cannot be installed in the same chassis.
- The uplink ports are fully functional on the redundant supervisor engine in standby mode.

**Note** In systems with redundant supervisor engines, both supervisor engines must be the same model and have the same daughter card configurations. Each supervisor engine must have the resources to run the switch on its own, which means all supervisor engine resources are duplicated. Identical supervisor engine memory configurations are recommended but are not required as long as the supervisor engine with the smaller memory configuration is sufficient to run the configured features of the switch. Additionally, each supervisor engine must have its own flash device and console port connections.

Additional information on the Catalyst 6506 switch chassis including data sheets and chassis installation is located at:

[http://www.cisco.com/en/US/products/hw/switches/ps708/tsd\\_products\\_support\\_series\\_home.html](http://www.cisco.com/en/US/products/hw/switches/ps708/tsd_products_support_series_home.html)

## Catalyst 6506-E

The Catalyst 6506-E switch is an enhanced version of the Catalyst 6506 switch. The 6-slot (numbered from (1) top to (6) bottom), 12 RU, horizontal chassis supports redundant power supplies and redundant supervisor engines. It also supports a greater power capacity per slot than the Catalyst 6506 switch chassis and supports the WS-X67xx and WS-X68xx switching modules. The Catalyst 6506-E switch chassis is NEBS L3 compliant. Supervisor engine support and restrictions for the Catalyst 6506-E includes:

- Supervisor Engine 2, Supervisor Engine 32, Supervisor Engine 32 PISA, Supervisor Engine 720, Supervisor Engine 720-10GE, and Supervisor Engine 2T are supported.

**Note** Refer to your software release notes for specific information on the minimum software release versions required to support the supervisor engines in the Catalyst 6506-E chassis.

- Supervisor Engine 2 must be installed in slot 1 or slot 2.
- Supervisor Engine 32, Supervisor Engine 32 PISA, Supervisor Engine 720, Supervisor Engine 720-10GE, and Supervisor Engine 2T must be installed in slot 5 or slot 6.

**Note** Slots not occupied by supervisor engines can be used for modules. Check your software release notes for any restrictions on the type of module that can be installed.

- Supervisor Engine 720, Supervisor Engine 720-10GE, Supervisor Engine 2T have a built-in switching fabric. Switch Fabric Modules (WS-C6500-SFM and WS-X6500-SFM2) are not supported by Supervisor Engine 720, Supervisor Engine 720-10GE, and Supervisor Engine 2T and cannot be installed in the same chassis.

- Supervisor Engine 32 and Supervisor Engine 32 PISA do not support the Switch Fabric Modules (WS-C6500-SFM and WS-X6500-SFM2). The Switch Fabric Modules and Supervisor Engine 32 or Supervisor Engine 32 PISA cannot be installed in the same chassis.
- The uplink ports are fully functional on the redundant supervisor engine in standby mode.

**Note** In systems with redundant supervisor engines, both supervisor engines must be the same model and have the same daughter card configurations. Each supervisor engine must have the resources to run the switch on its own, which means all supervisor engine resources are duplicated. Identical supervisor engine memory configurations are recommended but are not required as long as the supervisor engine with the smaller memory configuration is sufficient to run the configured features of the switch. Additionally, each supervisor engine must have its own flash device and console port connections.

Additional information on the Catalyst 6506-E switch chassis including data sheets and chassis installation is located at:

[http://www.cisco.com/en/US/products/hw/switches/ps708/tsd\\_products\\_support\\_series\\_home.html](http://www.cisco.com/en/US/products/hw/switches/ps708/tsd_products_support_series_home.html)

## Catalyst 6509

The Catalyst 6509 switch is a 9-slot (numbered from (1) top to (9) bottom), 15 RU, horizontal chassis that supports redundant power supplies and redundant supervisor engines. The chassis is NEBS L3 compliant. Supervisor engine support and restrictions for the Catalyst 6509 includes:

- Supervisor Engine 2, Supervisor Engine 32, Supervisor Engine 32 PISA, Supervisor Engine 720, and Supervisor Engine 720-10GE are supported.

**Note** Refer to your software release notes for specific information on the minimum software release versions required to support the supervisor engines in the Catalyst 6509 chassis.

- Supervisor Engine 2 must be installed in slot 1 or slot 2.
- Supervisor Engine 32, Supervisor Engine 32 PISA, Supervisor Engine 720, and Supervisor Engine 720-10GE must be installed in slot 5 or slot 6.

**Note** Slots not occupied by supervisor engines can be used for modules. Check your software release notes for any restrictions on the type of module that can be installed.

- Supervisor Engine 32, Supervisor Engine 32 PISA, Supervisor Engine 720, and Supervisor Engine 720-10GE require that the high-speed fan tray (WS-C6K-9SLOT-FAN2) be installed in the chassis. You must also install a 2500 W or higher capacity power supply in the chassis to power the high-speed fan tray.

**Note** The 2500 W power supply, when supporting the high-speed fan tray, can be powered from either 120 VAC or 220 VAC.

- Supervisor Engine 720 and Supervisor Engine 720-10GE have a built-in switching fabric. Switch Fabric Modules (WS-C6500-SFM and WS-X6500-SFM2) are not supported by Supervisor Engine 720 and Supervisor Engine 720-10GE. The Switch Fabric Modules and Supervisor Engine 720 or Supervisor Engine 720-10GE cannot be installed in the same chassis.

- Supervisor Engine 32 and Supervisor Engine 32 PISA do not support the Switch Fabric Modules (WS-C6500-SFM and WS-X6500-SFM2). The Switch Fabric Modules and Supervisor Engine 32 or Supervisor Engine 32 PISA cannot be installed in the same chassis.
- The uplink ports are fully functional on all redundant supervisor engine models when they are in standby mode.

**Note** In systems with redundant supervisor engines, both supervisor engines must be the same model and have the same daughter card configurations. Each supervisor engine must have the resources to run the switch on its own, which means all supervisor engine resources are duplicated. Identical supervisor engine memory configurations are recommended but are not required as long as the supervisor engine with the smaller memory configuration is sufficient to run the configured features of the switch. Additionally, each supervisor engine must have its own flash device and console port connections.

Additional information on the Catalyst 6509 switch chassis including data sheets and chassis installation is located at:

[http://www.cisco.com/en/US/products/hw/switches/ps708/tsd\\_products\\_support\\_series\\_home.html](http://www.cisco.com/en/US/products/hw/switches/ps708/tsd_products_support_series_home.html)

## Catalyst 6509-E

The Catalyst 6509-E switch is an enhanced version of the Catalyst 6509 switch. The 9-slot (numbered from (1) top to (9) bottom), 15 RU, horizontal chassis supports redundant power supplies and redundant supervisor engines. It also supports a greater power capacity per slot than the Catalyst 6509 switch chassis and supports the WS-X67xx and WS-X68xx switching modules. Supervisor engine support and restrictions for the Catalyst 6509-E includes:

- Supervisor Engine 2, Supervisor Engine 32, Supervisor Engine 32 PISA, Supervisor Engine 720, Supervisor Engine 720-10GE, and Supervisor Engine 2T are supported.

**Note** Refer to your software release notes for specific information on the minimum software release versions required to support the supervisor engines in the Catalyst 6509-E chassis.

- Supervisor Engine 2 must be installed in slot 1 or slot 2.
- Supervisor Engine 32, Supervisor Engine 32 PISA, Supervisor Engine 720, Supervisor Engine 720-10GE, and Supervisor Engine 2T must be installed in slot 5 or slot 6.

**Note** Slots not occupied by supervisor engines can be used for modules. Check your software release notes for any restrictions on the type of module that can be installed.

- Supervisor Engine 720, Supervisor Engine 720-10GE, and Supervisor Engine 2T have a built-in switching fabric. Switch Fabric Modules (WS-C6500-SFM and WS-X6500-SFM2) are not supported by Supervisor Engine 720, Supervisor Engine 720-10GE, and Supervisor Engine 2T and cannot be installed in the same chassis.

- Supervisor Engine 32 and Supervisor Engine 32 PISA do not support the Switch Fabric Modules (WS-C6500-SFM and WS-X6500-SFM2). The Switch Fabric Modules and Supervisor Engine 32 or Supervisor Engine 32 PISA cannot be installed in the same chassis.
- The uplink ports are fully functional on all redundant supervisor engine models when they are in standby mode.

**Note** In systems with redundant supervisor engines, both supervisor engines must be the same model and have the same daughter card configurations. Each supervisor engine must have the resources to run the switch on its own, which means all supervisor engine resources are duplicated. Identical supervisor engine memory configurations are recommended but are not required as long as the supervisor engine with the smaller memory configuration is sufficient to run the configured features of the switch. Additionally, each supervisor engine must have its own flash device and console port connections.

Additional information on the Catalyst 6509-E switch chassis including data sheets and chassis installation is located at:

[http://www.cisco.com/en/US/products/hw/switches/ps708/tsd\\_products\\_support\\_series\\_home.html](http://www.cisco.com/en/US/products/hw/switches/ps708/tsd_products_support_series_home.html)

## Catalyst 6509-NEB

The Catalyst 6509-NEB switch is a 9-slot (numbered from (1) right to (9) left), 20 RU, vertical chassis that supports redundant power supplies and redundant supervisor engines. The chassis is NEBS L3 compliant. Supervisor engine support and restrictions for the Catalyst 6509-NEB includes:

- Supervisor Engine 2 is supported.
- Supervisor Engine 32, Supervisor Engine 32 PISA, Supervisor Engine 720, and Supervisor Engine 720-10GE are supported if the WS-6509-NEB-UPGRD kit is installed.

**Note** Refer to your software release notes for specific information on the minimum software release versions required to support the supervisor engines in the Catalyst 6509-NEBchassis.

- Supervisor Engine 2 must be installed in slot 1 or slot 2.
- Supervisor Engine 32, Supervisor Engine 32 PISA, Supervisor Engine 720, and Supervisor Engine 720-10GE must be installed in slot 5 or slot 6.

**Note** Slots not occupied by supervisor engines can be used for modules. Check your software release notes for any restrictions on the type of module that can be installed.

- Supervisor Engine 720 and Supervisor Engine 720-10GE have a built-in switching fabric. Switch Fabric Modules (WS-C6500-SFM and WS-X6500-SFM2) are not supported by Supervisor Engine 720 and Supervisor Engine 720-10GE. The Switch Fabric Modules and Supervisor Engine 720 or Supervisor Engine 720-10GE cannot be installed in the same chassis.

- Supervisor Engine 32 and Supervisor Engine 32 PISA do not support the Switch Fabric Modules (WS-C6500-SFM and WS-X6500-SFM2). The Switch Fabric Modules and Supervisor Engine 32 or Supervisor Engine 32 PISA cannot be installed in the same chassis.
- The uplink ports are fully functional on all redundant supervisor engine models when they are in standby mode.

**Note** In systems with redundant supervisor engines, both supervisor engines must be the same model and have the same daughter card configurations. Each supervisor engine must have the resources to run the switch on its own, which means all supervisor engine resources are duplicated. Identical supervisor engine memory configurations are recommended but are not required as long as the supervisor engine with the smaller memory configuration is sufficient to run the configured features of the switch. Additionally, each supervisor engine must have its own flash device and console port connections.

Additional information on the Catalyst 6509-NEB switch chassis including data sheets and chassis installation is located at:

[http://www.cisco.com/en/US/products/hw/switches/ps708/tsd\\_products\\_support\\_series\\_home.html](http://www.cisco.com/en/US/products/hw/switches/ps708/tsd_products_support_series_home.html)

## Catalyst 6509-NEB-A

The Catalyst 6509-NEB-A switch is an enhanced version of the Catalyst 6509-NEB switch. The 9-slot (numbered from (1) right to (9) left), 21 RU, vertical chassis supports redundant power supplies and redundant supervisor engines. The Catalyst 6509-NEB-A switch chassis is NEBS L3 compliant. Supervisor engine support and restrictions for the Catalyst 6509-NEB-A includes:

- Supervisor Engine 2, Supervisor Engine 32, Supervisor Engine 32 PISA, Supervisor Engine 720, and Supervisor Engine 720-10GE are supported.

**Note** Refer to your software release notes for specific information on the minimum software release versions required to support the supervisor engines in the Catalyst 6509-NEB-A chassis.

- Supervisor Engine 2 must be installed in slot 1 or slot 2.
- Supervisor Engine 32, Supervisor Engine 32 PISA, Supervisor Engine 720, and Supervisor Engine 720-10GE must be installed in slot 5 or slot 6.

**Note** Slots not occupied by supervisor engines can be used for modules. Check your software release notes for any restrictions on the type of module that can be installed.

- Supervisor Engine 720 and Supervisor Engine 720-10GE have a built-in switching fabric. Switch Fabric Modules (WS-C6500-SFM and WS-X6500-SFM2) are not supported by Supervisor Engine 720 and Supervisor Engine 720-10GE. The Switch Fabric Modules and Supervisor Engine 720 or Supervisor Engine 720-10GE cannot be installed in the same chassis.

- Supervisor Engine 32 and Supervisor Engine 32 PISA do not support the Switch Fabric Modules (WS-C6500-SFM and WS-X6500-SFM2). The Switch Fabric Modules and Supervisor Engine 32 or Supervisor Engine 32 PISA cannot be installed in the same chassis.
- The uplink ports are fully functional on all redundant supervisor engine models when they are in standby mode.

**Note** In systems with redundant supervisor engines, both supervisor engines must be the same model and have the same daughter card configurations. Each supervisor engine must have the resources to run the switch on its own, which means all supervisor engine resources are duplicated. Identical supervisor engine memory configurations are recommended but are not required as long as the supervisor engine with the smaller memory configuration is sufficient to run the configured features of the switch. Additionally, each supervisor engine must have its own flash device and console port connections.

Additional information on the Catalyst 6509-NEB-A switch chassis including data sheets and chassis installation is located at:

[http://www.cisco.com/en/US/products/hw/switches/ps708/tsd\\_products\\_support\\_series\\_home.html](http://www.cisco.com/en/US/products/hw/switches/ps708/tsd_products_support_series_home.html)

## Catalyst 6509-V-E

The Catalyst 6509-V-E switch is an enhanced version of the Catalyst 6509-NEB-A switch. The 9-slot (numbered from (1) right to (9) left), 21 RU, vertical chassis supports redundant power supplies, redundant supervisor engines, and redundant fan trays. It also supports a greater power capacity per slot than the Catalyst 6509-NEB-A switch chassis. The Catalyst 6509-V-E switch chassis is NEBS L3 compliant. Supervisor engine support and restrictions for the Catalyst 6509-V-E includes:

- Supervisor Engine 32, Supervisor Engine 32 PISA, Supervisor Engine 720, Supervisor Engine 720-10GE, and Supervisor Engine 2T are supported.

**Note** Refer to your software release notes for specific information on the minimum software release versions required to support the supervisor engines in the Catalyst 6509-NEB-A chassis.

- Supervisor Engine 32, Supervisor Engine 32 PISA, Supervisor Engine 720, Supervisor Engine 720-10GE, and Supervisor Engine 2T must be installed in slot 5 or slot 6.

**Note** Slots not occupied by supervisor engines can be used for modules. Check your software release notes for any restrictions on the type of module that can be installed.

- Supervisor Engine 720, Supervisor Engine 720-10GE, and Supervisor Engine 2T have a built-in switching fabric. Switch Fabric Modules (WS-C6500-SFM and WS-X6500-SFM2) are not supported by Supervisor Engine 720, Supervisor Engine 720-10GE, and Supervisor Engine 2T and cannot be installed in the same chassis.



- Supervisor Engine 32 and Supervisor Engine 32 PISA do not support the Switch Fabric Modules (WS-C6500-SFM and WS-X6500-SFM2). The Switch Fabric Modules and Supervisor Engine 32 or Supervisor Engine 32 PISA cannot be installed in the same chassis.
- The uplink ports are fully functional on all redundant supervisor engine models when they are in standby mode.

**Note** In systems with redundant supervisor engines, both supervisor engines must be the same model and have the same daughter card configurations. Each supervisor engine must have the resources to run the switch on its own, which means all supervisor engine resources are duplicated. Identical supervisor engine memory configurations are recommended but are not required as long as the supervisor engine with the smaller memory configuration is sufficient to run the configured features of the switch. Additionally, each supervisor engine must have its own flash device and console port connections.

Additional information on the Catalyst 6509-V-E switch chassis including data sheets and chassis installation is located at:

[http://www.cisco.com/en/US/products/hw/switches/ps708/tsd\\_products\\_support\\_series\\_home.html](http://www.cisco.com/en/US/products/hw/switches/ps708/tsd_products_support_series_home.html)

## Catalyst 6513

The Catalyst 6513 switch is a 13-slot (numbered from (1) top to (13) bottom), 20 RU, horizontal chassis that supports redundant power supplies and redundant supervisor engines. The chassis is NEBS L3 compliant. Supervisor engine support and restrictions for the Catalyst 6513 includes:

- Supports Supervisor Engine 2, Supervisor Engine 32, Supervisor Engine 32 PISA, Supervisor Engine 720, and Supervisor Engine 720-10GE.

**Note** Refer to your software release notes for specific information on the minimum software release versions required to support the supervisor engines in the Catalyst 6513 chassis.

- Supervisor Engine 2 must be installed in slot 1 or slot 2.
- Supervisor Engine 32, Supervisor Engine 32 PISA, Supervisor Engine 720, and Supervisor Engine 720-10GE must be installed in slot 7 or slot 8.

**Note** Slots not occupied by supervisor engines can be used for modules. Check your software release notes for any restrictions on the type of module that can be installed.

- Supervisor Engine 32, Supervisor Engine 32 PISA, Supervisor Engine 720, and Supervisor Engine 720-10GE require additional cooling. You must install the high-speed fan tray (WS-C6K-13SLT-FAN2) when using any of these supervisor engines. You must also install a 2500 W or higher capacity power supply in the chassis to power the high-speed fan tray.
- Supervisor Engine 720 and Supervisor Engine 720-10GE have a built-in switching fabric. Switch Fabric Modules (WS-C6500-SFM and WS-X6500-SFM2) are not supported by Supervisor Engine 720 and Supervisor Engine 720-10GE. The Switch Fabric Modules and Supervisor Engine 720 or Supervisor Engine 720-10GE cannot be installed in the same chassis.

- Supervisor Engine 32 and Supervisor Engine 32 PISA do not support the Switch Fabric Modules (WS-C6500-SFM and WS-X6500-SFM2). The Switch Fabric Modules and Supervisor Engine 32 or Supervisor Engine 32 PISA cannot be installed in the same chassis.
- The uplink ports are fully functional on all redundant supervisor engine models when they are in standby mode.

**Note** In systems with redundant supervisor engines, both supervisor engines must be the same model and have the same daughter card configurations. Each supervisor engine must have the resources to run the switch on its own, which means all supervisor engine resources are duplicated. Identical supervisor engine memory configurations are recommended but are not required as long as the supervisor engine with the smaller memory configuration is sufficient to run the configured features of the switch. Additionally, each supervisor engine must have its own flash device and console port connections.

Additional information on the Catalyst 6513 switch chassis including data sheets and chassis installation is located at:

[http://www.cisco.com/en/US/products/hw/switches/ps708/tsd\\_products\\_support\\_series\\_home.html](http://www.cisco.com/en/US/products/hw/switches/ps708/tsd_products_support_series_home.html)

## Catalyst 6513-E

The Catalyst 6513-E switch is a 13-slot (numbered from (1) top to (13) bottom), 20 RU, horizontal chassis enhanced version of the Catalyst 6513 switch that supports redundant power supplies and redundant supervisor engines. It also supports a greater power capacity per slot than the Catalyst 6513 switch chassis and supports the WS-X67xx and WS-X68xx switching modules. The chassis is NEBS L3 compliant. Supervisor engine support and restrictions for the Catalyst 6513-E includes:

- Supports Supervisor Engine 2, Supervisor Engine 32, Supervisor Engine 32 PISA, Supervisor Engine 720, Supervisor Engine 720-10GE, and Supervisor Engine 2T.

**Note** Refer to your software release notes for specific information on the minimum software release versions required to support the supervisor engines in the Catalyst 6513-E chassis.

- Supervisor Engine 2 must be installed in slot 1 or slot 2.
- Supervisor Engine 32, Supervisor Engine 32 PISA, Supervisor Engine 720, Supervisor Engine 720-10GE, and Supervisor Engine 2T must be installed in slot 7 or slot 8.

**Note** Slots not occupied by supervisor engines can be used for modules. Check your software release notes for any restrictions on the type of module that can be installed.

- Supervisor Engine 32, Supervisor Engine 32 PISA, Supervisor Engine 720, Supervisor Engine 720-10GE, and Supervisor Engine 2T require additional cooling. You must install the high-speed fan tray (WS-C6K-13SLT-FAN2) when using any of these supervisor engines. You must also install a 2500 W or higher capacity power supply in the chassis to power the high-speed fan tray.
- Supervisor Engine 720, Supervisor Engine 720-10GE, and Supervisor Engine 2T have a built-in switching fabric. Switch Fabric Modules (WS-C6500-SFM and WS-X6500-SFM2) are not supported.

- Supervisor Engine 32 and Supervisor Engine 32 PISA do not support the Switch Fabric Modules (WS-C6500-SFM and WS-X6500-SFM2). The Switch Fabric Modules and Supervisor Engine 32 or Supervisor Engine 32 PISA cannot be installed in the same chassis.
- The uplink ports are fully functional on all redundant supervisor engine models when they are in standby mode.

In systems with redundant supervisor engines, both supervisor engines must be the same model and have the same daughter card configurations. Each supervisor engine must have the resources to run the switch on its own, which means all supervisor engine resources are duplicated. Identical supervisor engine memory configurations are recommended but are not required as long as the supervisor engine with the smaller memory configuration is sufficient to run the configured features of the switch. Additionally, each supervisor engine must have its own flash device and console port connections.

Additional information on the Catalyst 6513-E switch chassis including data sheets and chassis installation is located at:

[http://www.cisco.com/en/US/products/hw/switches/ps708/tsd\\_products\\_support\\_series\\_home.html](http://www.cisco.com/en/US/products/hw/switches/ps708/tsd_products_support_series_home.html)





# CHAPTER 2

## Supervisor Engines

---

Revised: July 2011

This chapter describes the supervisor engines supported on the Catalyst 6500 series switches and contains these sections:

- [Supervisor Engine 2, page 2-1](#)
- [Supervisor Engine 32, page 2-7](#)
- [Supervisor Engine 32 PISA, page 2-14](#)
- [Supervisor Engine 720, page 2-21](#)
- [Supervisor Engine 720-10GE, page 2-26](#)
- [Supervisor Engine 2T, page 2-33](#)

## Supervisor Engine 2

[Table 2-1](#) lists the three available versions of Supervisor Engine 2 and provides a brief description of each. [Figure 2-1](#) shows the faceplate of Supervisor Engine 2 with the major features identified.

**Table 2-1** *Supervisor Engine 2 Versions*

Supervisor Engine 2 Product Number	Description
WS-X6K-S2-PFC2	Supervisor Engine 2 (WS-X6K-S2-PFC2) is shipped with a factory-installed PFC2 daughter card (WS-F6K-PFC2); there is no MSFC daughter card installed. This version of Supervisor Engine 2 supports only the Catalyst operating system; it does not support Cisco IOS. Supervisor Engine 2 has two 1000BASE-X uplink ports that require the installation of GBIC transceivers.

**Table 2-1 Supervisor Engine 2 Versions (continued)**

Supervisor Engine 2 Product Number	Description
WS-X6K-S2-MSFC2	Supervisor Engine 2 (WS-X6K-S2-MSFC2) comes with a factory-installed PFC2 daughter card (WS-F6K-PFC2) and a factory-installed MSFC2 daughter card (WS-F6K-MSFC2). It has two 1000BASE-X uplink ports that require the installation of GBIC transceivers.
WS-X6K-S2U-MSFC2	Supervisor Engine 2 (WS-X6K-S2U-MSFC2) comes with a factory-installed PFC2 daughter card (WS-F6K-PFC2) and a factory-installed MSFC2 daughter card (WS-F6K-MSFC2). Supervisor Engine 2 has two 1000BASE-X uplink ports that require the installation of GBIC transceivers. The MSFC2 comes equipped with 512 MB of memory.

**Figure 2-1 Supervisor Engine 2 Front Panel Features**

Table 2-2 lists and describes Supervisor Engine 2 features

**Table 2-2 Supervisor Engine 2 Features**

Feature	Description
Chassis compatibility	Supported on all Catalyst 6500 series chassis except the Catalyst 6509-V-E chassis.
Software requirements (minimum)	12.2(17d)SXB
Fan tray requirements	All three versions of Supervisor Engine 2 are designed to operate with the low-speed fan trays; they do not require that a high-speed fan tray (either a fan tray 2 or Catalyst 6500-E series fan tray) be installed in the chassis. Low-speed fan trays provide sufficient cooling for Supervisor Engine 2.
Slot installation restrictions	Slots 1 and 2 in any Catalyst 6500 series chassis
Backplane	32-Gbps shared bus. 256 Gbps when a Switch Fabric Module (WS-C6500-SFM or WS-X6500-SFM2) is installed in the chassis.
Hardware restrictions	There are no additional hardware restrictions for Supervisor Engine 2.

Table 2-2 Supervisor Engine 2 Features (continued)

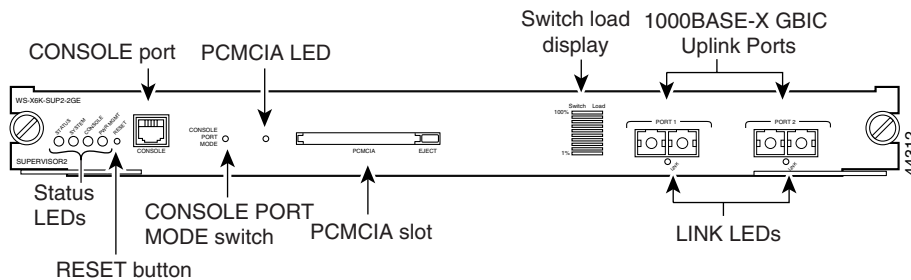
Feature	Description
Memory	
SP DRAM	<ul style="list-style-type: none"> <li>• WS-X6K-S2-PFC2 and WS-X6K-S2-MSFC2—128 MB (default); upgradeable to 512 MB.</li> <li>• WS-X6K-S2U-MSFC2—256 MB (default); upgradeable to 512 MB.</li> </ul>
SP NVRAM	512 KB
SP onboard flash	32 MB
Front panel features	
Status LEDs	See <a href="#">Table 2-4</a> for a list of the status LEDs and their descriptions.
RESET switch	<p>The RESET switch allows you to reset and restart the switch.</p> <p><b>Note</b> Use a ballpoint pen tip or other small, pointed object to access the RESET button.</p>
CONSOLE port	<p>One 10/100/1000 port that uses an RJ-45 connector. The CONSOLE port allows you to access the switch either locally (with a console terminal) or remotely (with a modem). The CONSOLE port is an EIA/TIA-232 asynchronous, serial connection with hardware flow control.</p> <p>The CONSOLE port has an LED associated with it.</p>
PCMCIA slot options	<p>One PCMCIA slot is available. The Flash PC card (PCMCIA) slot holds a Flash PC card for additional flash memory. You can use this flash memory to store and run software images or to serve as an I/O device. Supports a 64 MB (p/n MEM-C6K-ATA-1-64M=) ATA Flash PC card. An eject button is located on the right side, next to the slot. Pushing in on the button ejects the Flash PC card from the slot.</p> <p>The PCMCIA slot has an LED associated with it.</p>
Uplink ports	<p>Supervisor Engine 2 has two 1000BASE-X uplink ports. The two 1000BASE-X uplink ports require GBIC transceivers.</p> <p>The uplink ports have LEDs associated with them.</p> <p><b>Note</b> In chassis configurations where there are redundant supervisor engines installed, the uplink ports on the supervisor engine that is in standby mode are fully functional.</p>
Uplink port queue structure	<p>Tx—1p2q2t</p> <p>Rx—1p1q4t</p>

**Table 2-2 Supervisor Engine 2 Features (continued)**

Feature	Description
Buffer size	WS-X6K-S2-PFC2, WS-X6K-S2-MSFC2, and WS-X6K-S2U-MSFC2 <ul style="list-style-type: none"> <li>Total buffer size—512 KB</li> <li>Rx/Tx buffer size—80 KB/432 KB</li> </ul>
Pluggable transceivers supported	Supervisor Engine 2 supports copper and optical GBIC transceivers for the uplink ports.
Hardware-based forwarding engine daughter card (Policy Feature Card)	All three versions of Supervisor Engine 2 have the PFC2 daughter card (WS-F6K-PFC2) installed
Multilayer Switch Feature Card (MSFC) daughter card version installed	<ul style="list-style-type: none"> <li>WS-X6K-SUP2-PFC2—No MSFC2 daughter card installed</li> <li>WS-X6K-SUP2-MSFC2—MSFC2 daughter card (WS-F6K-MSFC2)</li> <li>WS-X6K-S2U-MSFC2—MSFC2 daughter card (WS-F6K-MSFC2)</li> </ul>

Table 2-3 lists the physical and environmental specifications for Supervisor Engine 2.

**Table 2-3 Supervisor Engine 2 Physical and Environmental Specifications**

Item	Specification
Dimensions (H x W x D)	1.6 x 15.3 x 16.3 in. (4.06 x 38.86 x 41.40 cm). Occupies one slot in the chassis.
Weight	<ul style="list-style-type: none"> <li>WS-X6K-SUP2-PFC2—9.2 lb (4.17 kg)</li> <li>WS-X6K-SUP2-MSFC2—9.6 lb (4.35 kg)</li> <li>WS-X6K-S2U-MSFC2—9.6 lb (4.35 kg)</li> </ul>
Power requirement (at 42 VDC)	<ul style="list-style-type: none"> <li>WS-X6K-SUP2-PFC2—2.66 A</li> <li>WS-X6K-SUP2-MSFC2—3.06 A</li> <li>WS-X6K-S2U-MSFC2—3.06 A</li> </ul>
<b>Environment</b>	
Operating temperature	<ul style="list-style-type: none"> <li>Certified for operation: 32° to 104°F (0° to 40°C)</li> <li>Designed and tested for operation: 32° to 130°F (0° to 55°C)</li> </ul>
Humidity (RH) ambient (noncondensing)	10 to 90%
Operating altitude	<ul style="list-style-type: none"> <li>Certified for operation: 0 to 6500 feet (0 to 2000 m)</li> <li>Designed and tested for operation: -200 to 10,000 feet (-60 to 3000 m)</li> </ul>



Table 2-4 lists Supervisor Engine 2 front panel LEDs and their meanings.

**Table 2-4 Supervisor Engine 2 Front Panel LEDs**

LED	Color and Meaning
STATUS	<ul style="list-style-type: none"> <li>• Green—All diagnostics pass. The supervisor engine is operational (normal initialization sequence).</li> <li>• Orange—The supervisor engine is booting or running diagnostics (normal initialization sequence) or an overtemperature condition has occurred. (A minor temperature threshold has been exceeded during environmental monitoring.)</li> <li>• Red—The diagnostic test failed. The supervisor engine is not operational because a fault occurred during the initialization sequence or an overtemperature condition has occurred. (A major temperature threshold has been exceeded during environmental monitoring.)</li> </ul>
SYSTEM	<ul style="list-style-type: none"> <li>• Green—All chassis environmental monitors are reporting OK.</li> <li>• Orange—The power supply has failed or the power supply fan has failed.</li> <li>• Red—Incompatible power supplies are installed.               <ul style="list-style-type: none"> <li>– The redundant clock has failed.</li> <li>– One VTT<sup>1</sup> module has failed or the VTT module temperature minor threshold has been exceeded<sup>2</sup>.</li> <li>– Two VTT modules fail or the VTT module temperature major threshold has been exceeded<sup>3</sup>.</li> <li>– The temperature of the supervisor engine major threshold has been exceeded.</li> </ul> </li> </ul>
CONSOLE	<ul style="list-style-type: none"> <li>• Green—The port is active.</li> <li>• Orange—The port is disabled.</li> <li>• Off—The port is not active or the link is not connected.</li> </ul>

**Table 2-4 Supervisor Engine 2 Front Panel LEDs (continued)**

LED	Color and Meaning
PWR MGMT	<ul style="list-style-type: none"> <li>Green—Sufficient power is available for all modules.</li> <li>Orange—There is insufficient power for all modules to power up.</li> </ul>
LINK (Uplink ports)	<ul style="list-style-type: none"> <li>Green—The port is active (the link is connected and operational).</li> <li>Flashing orange—The port failed diagnostics and is disabled.</li> <li>Orange—The port is disabled.</li> <li>Red—The supervisor engine is resetting; an overtemperature condition has occurred.</li> </ul> <p><b>Note</b> If the supervisor engine fails to download code and configuration information successfully during the initial reset, the LED stays red; the supervisor engine does not come online.</p> <ul style="list-style-type: none"> <li>Off—The port is not active or the link is not connected.</li> </ul>
SWITCH LOAD	If the switch is operational, the switch load bar meter indicates (as an approximate percentage) the current traffic load over the backplane.
PCMCIA	Green—The installed Flash PC card is being accessed and is performing either a read or a write operation.

1. VTT = voltage termination module. The VTT module terminates signals on the Catalyst switching bus.
2. If no redundant supervisor engine is installed and there is a VTT module minor or major overtemperature condition, the system shuts down.

# Supervisor Engine 32

Table 2-5 lists the four available versions of Supervisor Engine 32 and provides a brief description of each. Figure 2-2 shows the faceplate of Supervisor Engine 32 (WS-SUP32-GE-3B) with the major features identified. Figure 2-3 shows the faceplate of Supervisor Engine 32 (WS-SUP32-10GE-3B) with the major features identified.

**Table 2-5 Supervisor Engine 32 Product Numbers and Descriptions**

Supervisor Engine 32 Product Number	Description
WS-SUP32-GE-3B	Supervisor Engine 32 (WS-SUP32-GE-3B) is shipped with a factory-installed PFC3B daughter card (WS-F6K-PFC3B) and an MSFC2A daughter card (WS-F6K-MSFC2A). Supervisor Engine 32 has nine uplink ports: eight 1000BASE-X Ethernet uplink ports that require the installation of Small Form-Factor Pluggable (SFP) transceivers and one 10/100/100 port with an RJ-45 connector.
WS-SUP32-10GE-3B	Supervisor Engine 32 (WS-SUP32-GE-3B) is shipped with a factory-installed PFC3B daughter card (WS-F6K-PFC3B) and an MSFC2A daughter card (WS-F6K-MSFC2A). Supervisor Engine 32 has three uplink ports: two 10-Gigabit Ethernet uplink ports that require the installation of XENPAK transceivers and one 10/100/1000 port with an RJ-45 connector.

**Figure 2-2 Supervisor Engine 32 (WS-SUP32-GE-3B) Front Panel Features**

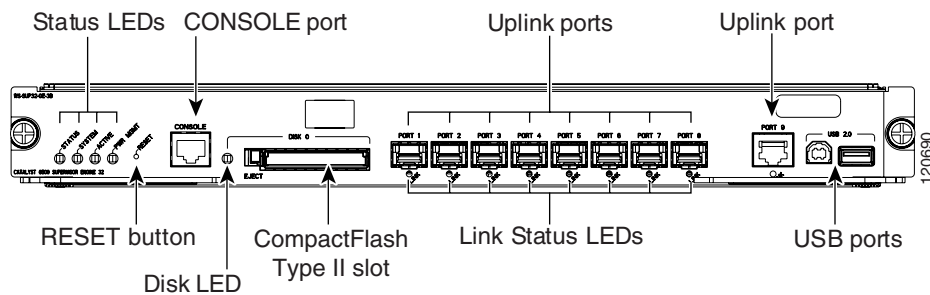

Figure 2-3 Supervisor Engine 32 (WS-SUP32-10GE-3B) Front Panel Features

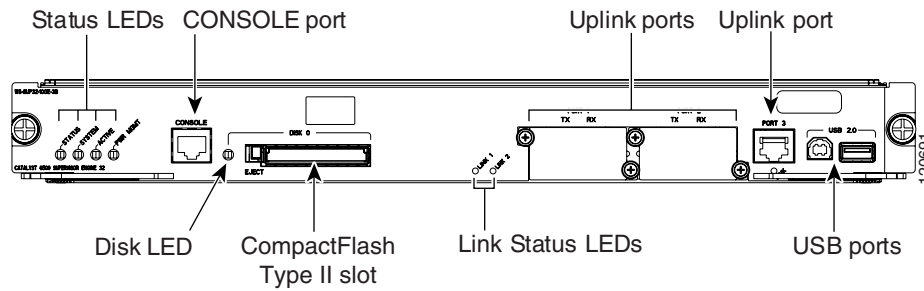

Table 2-6 lists and describes Supervisor Engine 32 features.

Table 2-6 Supervisor Engine 32 Features

Feature	Description
Chassis compatibility	Supported on all Catalyst 6500 series chassis.
Software requirements (minimum)	12.2(18)SXF
Fan tray requirements	All versions of Supervisor Engine 32 require that a high-speed fan tray (either a fan tray 2 or Catalyst 6500-E series fan tray) be installed in the chassis. Low-speed fan trays do not provide sufficient cooling for Supervisor Engine 32. <b>Note</b> The high-speed fan trays require that you install a 2500 W or higher capacity power supply in the chassis to power the fan tray.
Slot installation restrictions	Supervisor Engine 32 must be installed in: <ul style="list-style-type: none"> <li>• Slots 1 and 2 in a 3-slot or a 4-slot chassis</li> <li>• Slots 5 and 6 in a 6-slot or a 9-slot chassis</li> <li>• Slots 7 and 8 in a 13-slot chassis</li> </ul> <b>Note</b> The primary supervisor engine can be installed in either slot.
Backplane	32-Gbps shared bus. <b>Note</b> Supervisor Engine 32 does not include and does not support switch fabric.

**Table 2-6** Supervisor Engine 32 Features (continued)

Feature	Description
Hardware restrictions	<p>Supervisor Engine 32 does not support:</p> <ul style="list-style-type: none"> <li>• WS-F6K-PFC3A Policy Feature Card 3A (PFC3A)</li> <li>• WS-F6K-PFC3BXL Policy Feature Card 3BXL (PFC3BXL)</li> <li>• Distributed Forwarding Cards (DFCs).</li> </ul> <p><b>Note</b> Installed DFCs do not power up with Supervisor Engine 32.</p> <ul style="list-style-type: none"> <li>• Switch Fabric Modules (WS-C6500-SFM and WS-X6500-SFM2)</li> <li>• Ethernet modules not supported include: <ul style="list-style-type: none"> <li>– WS-6716-10GE (16-port 10-Gigabit Ethernet module)</li> <li>– WS-6708-10-GE (8-port 10-Gigabit Ethernet module)</li> <li>– WS-X6704-10GE (4-port 10-Gigabit Ethernet module)</li> <li>– WS-X6748-SFP (48-port Gigabit Ethernet module)</li> <li>– WS-X6816-GBIC (16-port Gigabit Ethernet module)</li> <li>– WS-X6748-GE-TX (48-port 10/100/1000 Ethernet module)</li> </ul> </li> <li>• Optical Service Modules (OSMs)</li> <li>• WS-X6182-2PA FlexWAN module. (The WS-X6582-2PA Enhanced FlexWAN module is supported.)</li> <li>• Service modules not supported include: <ul style="list-style-type: none"> <li>– WS-SVC-WISM-1-K9 Wireless Services Module (WiSM)</li> <li>– WS-SVC-AON-1-K9 Application-Oriented Networking (AON) Module</li> <li>– WS-SVC-AGM-1-K9 Anomaly Guard Module</li> <li>– WS-SVC-ADM-1-K9 Traffic Anomaly Detector Module</li> <li>– WS-SVC-CSG-1 Content Services Gateway module</li> <li>– WS-X6066-SLB-APC Content Switching Module (CSM)</li> <li>– WS-X6066-SLB-S-K9 Content Switching Module with SSL (CSM-S)</li> <li>– WS-SVC-PSD-1 Persistent Storage Device (PSD) module</li> <li>– WS-SVC-WLAN-1-K9 Wireless LAN Services module</li> <li>– WS-SVC-IPSEC-1 IPsec VPN Accelerated Forwarding card</li> </ul> </li> </ul>

Table 2-6 Supervisor Engine 32 Features (continued)

Feature	Description
Memory	
Switch Processor DRAM	<ul style="list-style-type: none"> <li>• 256 MB (supervisor engines shipped before May, 2005)</li> <li>• 512 MB (supervisor engines shipped after May, 2005)</li> <li>• Upgradeable to 1 GB using MEM-xCEF720-1GB memory kit</li> </ul>
Route Processor DRAM	<ul style="list-style-type: none"> <li>• 256 MB (supervisor engines shipped before May, 2005)</li> <li>• 512 MB (supervisor engines shipped after May, 2005)</li> <li>• Upgradeable to 1 GB using MEM-xCEF720-1GB memory kit</li> </ul>
Switch Processor Bootflash/Bootdisk	256 MB
Route Processor Bootflash	64 MB
CompactFlash (disk0)	Compact flash Type 2 (supports 64, 128, 256, 512 MB, and 1 GB)
Front panel features	
Status LEDs	See <a href="#">Table 2-8</a> for a list of the status LEDs and their descriptions.
RESET switch	<p>The RESET switch allows you to reset and restart the switch.</p> <p><b>Note</b> Because the reset switch is recessed in the faceplate, you must use a ballpoint pen tip or other small, pointed object to access the switch.</p>
CONSOLE port	This is a 10/100/1000 port that uses an RJ-45 connector. The CONSOLE port allows you to access the switch either locally (with a console terminal) or remotely (with a modem). The CONSOLE port is an EIA/TIA-232 asynchronous, serial connection with hardware flow control.
DISK 0 (PCMCIA) slot and LED	<p>One PCMCIA slot is available. The PCMCIA slot allows a Flash PC card to be installed providing additional flash memory. You can use this flash memory to store and run software images or to serve as an I/O device. An eject button is located on the left side, next to the slot. Pushing in on the button ejects the PCMCIA card from the slot.</p> <p>The PCMCIA slot has an LED associated with it.</p>

Table 2-6 Supervisor Engine 32 Features (continued)

Feature	Description
Uplink ports (PORT 1 through PORT 9)             Universal Serial Bus (USB) port	<ul style="list-style-type: none"> <li>• The WS-SUP32-GE-3B has nine uplink ports: Eight 1000BASE-X SFP ports and one 10/100/1000BASE RJ-45 port. All nine uplink ports can be used at one time.</li> </ul> <p><b>Note</b> The eight 1000BASE-T or 1000BASE-X uplink ports require SFP transceivers to be installed.</p> <ul style="list-style-type: none"> <li>• The WS-SUP32-10GE-3B has three uplink ports: two 10-Gigabit XENPAK ports and one 10/100/1000BASE RJ-45 port. All three ports can be used at one time</li> </ul> <p><b>Note</b> The two 10-Gigabit uplink ports require XENPAK transceivers to be installed.</p> <p><b>Note</b> In chassis configurations where there are redundant supervisor engines installed, the uplink ports on the supervisor engine that is in standby mode are fully functional.</p> <p>Each uplink port has a LINK LED associated with it.</p> <p>Two USB 2.0 ports are provided. Currently, they are not enabled.</p>
Uplink port queue structure (Tx/Rx)	1p3q8t/2q8t
Buffer size	<ul style="list-style-type: none"> <li>• WS-SUP32-GE-3B:               <ul style="list-style-type: none"> <li>– Total buffer size—10 MB</li> <li>– Rx/Tx buffer size—5 MB/5 MB</li> </ul> </li> <li>• Sup32-10GE-3B:               <ul style="list-style-type: none"> <li>– Total buffer size—17.7 MB</li> <li>– Rx/Tx buffer size—9.6 MB/8.1 MB</li> </ul> </li> </ul>
Pluggable transceivers supported	<ul style="list-style-type: none"> <li>• WS-SUP32-GE-3B—1-GB SFP transceivers are supported in eight uplink ports.</li> <li>• WS-SUP32-10GE-3B—10-GB XENPAK transceivers are supported in the two uplink ports.</li> </ul> <p><b>Note</b> See Appendix A for a list and a description of the SFP and XENPAK transceivers that are supported.</p>
Hardware-based forwarding engine (Policy Feature Card)	<p>The PFC3B is installed on all versions of Supervisor Engine 32</p> <p><b>Note</b> The WS-F6K-PFC3A Policy Feature Card 3A (PFC3A) and the WS-F6K-PFC3BXL Policy Feature Card 3BXL (PFC3BXL) are not supported.</p>
Multilayer Switch Feature Card (MSFC) daughter card version installed	MSFC2A

Table 2-7 lists the physical and environmental specifications for Supervisor Engine 32.

**Table 2-7 Supervisor Engine 32 Physical and Environmental Specifications**

Item	Specification
Dimensions (H x W x D)	1.6 x 15.3 x 16.3 in. (4.06 x 38.86 x 41.40 cm). Occupies one slot in the chassis.
Weight	WS-SUP32-GE-3B—9.8 lb (4.45 kg) WS-SUP32-10GE-3B—9.6 lb (4.35 kg)
Power requirement (at 42 VDC)	<ul style="list-style-type: none"> <li>WS-SUP32-GE-3B—3.69 A</li> <li>WS-SUP32-10GE-3B—4.19 A</li> </ul>
<b>Environment</b>	
Operating temperature	<ul style="list-style-type: none"> <li>Certified for operation: 32° to 104°F (0° to 40°C)</li> <li>Designed and tested for operation: 32° to 130°F (0° to 55°C)</li> </ul>
Humidity (RH) ambient (noncondensing)	10 to 90%
Operating altitude	<ul style="list-style-type: none"> <li>Certified for operation: 0 to 6500 feet (0 to 2000 m)</li> <li>Designed and tested for operation: -200 to 10,000 feet (-60 to 3000 m)</li> </ul>

Table 2-8 lists Supervisor Engine 32 front panel LEDs and their meanings.

**Table 2-8 Supervisor Engine 32 Front Panel Status LEDs**

LED	Color and Meaning
STATUS	<p>The STATUS LED indicates the status of the supervisor engine.</p> <ul style="list-style-type: none"> <li>Green—All diagnostics pass. The supervisor engine is operational (normal initialization sequence).</li> <li>Orange—The supervisor engine is booting or running diagnostics (normal initialization sequence) or an overtemperature condition has occurred. (A minor temperature threshold has been exceeded during environmental monitoring.)</li> <li>Red—The diagnostic test failed. The supervisor engine is not operational because a fault occurred during the initialization sequence or an overtemperature condition has occurred. (A major temperature threshold has been exceeded during environmental monitoring.)</li> </ul>
SYSTEM	<p>The SYSTEM LED indicates the status of the system components.</p> <ul style="list-style-type: none"> <li>Green—All chassis environmental monitors are reporting OK.</li> <li>Orange—A minor hardware problem has been detected.</li> <li>Red—A major hardware problem has occurred.</li> </ul>



**Table 2-8 Supervisor Engine 32 Front Panel Status LEDs (continued)**

<b>LED</b>	<b>Color and Meaning</b>
ACTIVE	<p>The ACTIVE LED indicates whether the supervisor engine is operating in active mode or is in standby mode.</p> <ul style="list-style-type: none"> <li>• Green—The supervisor engine is operational and active.</li> <li>• Orange—The supervisor engine is in standby mode.</li> </ul>
PWR MGMT	<p>The supervisor engine monitors each module's power requirements and status relative to the system's overall power capacity before fully powering up each module in the chassis.</p> <ul style="list-style-type: none"> <li>• Orange—Power-up mode; running self-diagnostics.</li> <li>• Green—Power management is functioning normally and sufficient power is available for all modules.</li> <li>• Orange—A minor power management problem has been detected. There is insufficient power for all modules to power up.</li> <li>• Red—A major power failure has occurred.</li> </ul>
DISK 0 (PCMCIA) LED	<p>Green—The installed Flash PC card is being accessed and is performing either a read or a write operation.</p>
LINK	<p>The LINK LED indicates the link status of the corresponding port. For the eight SFP transceiver uplink ports plus the 10/100/1000 copper port, the LED colors indicate the following:</p> <ul style="list-style-type: none"> <li>• Green—The port is active (the link is connected and operational).</li> <li>• Flashing orange—The port failed diagnostics and is disabled.</li> <li>• Orange—The port is disabled.</li> <li>• Red—The supervisor engine is resetting; an overtemperature condition has occurred.</li> </ul> <p><b>Note</b> If the supervisor engine fails to download code and configuration information successfully during the initial reset, the LED stays red; the supervisor engine does not come online.</p> <p>Off—The port is not active or the link is not connected.</p> <p>For LINK LEDs associated with the XENPAK transceiver uplink ports, the LED colors indicate the following:</p> <ul style="list-style-type: none"> <li>• Green—The XENPAK transceiver is installed, a network interface cable is attached, and a network link is established.</li> <li>• Orange—The XENPAK transceiver is installed, the network interface cable is attached, but there is no network link established.</li> <li>• Off—Either the uplink port socket is empty (no XENPAK transceiver is installed) or the XENPAK transceiver is installed, but does not have a network cable attached.</li> </ul>

# Supervisor Engine 32 PISA

Table 2-9 lists the available versions of Supervisor Engine 32 PISA and provides a brief description of each. Figure 2-4 shows the faceplate of the WS-S32-GE-PISA with the major features identified. Figure 2-5 shows the faceplate of the WS-S32-10GE-PISA with the major features identified.

**Table 2-9 Supervisor Engine 32 PISA Product Numbers and Descriptions**

Supervisor Engine 32 Product Number	Description
WS-S32-GE-PISA	The WS-S32-GE-PISA is shipped with a factory-installed PFC3B daughter card (WS-F6K-PFC3B) and a Programmable IP Services Accelerator (PISA) daughter card. The PISA daughter card replaces the MSFC2A daughter card. Supervisor Engine 32 has nine uplink ports: eight 1000BASE-X Ethernet uplink ports that require the installation of Small Form-Factor Pluggable (SFP) transceivers and one 10/100/1000 port with an RJ-45 connector. Eight uplink ports can be used at one time.
WS-S32-10GE-PISA	The WS-S32-10GE-PISA is shipped with a factory-installed PFC3B daughter card (WS-F6K-PFC3B) and a Programmable IP Services Accelerator (PISA) daughter card. The PISA daughter card replaces the MSFC2A daughter card. Supervisor Engine 32 has three uplink ports: two 10-Gigabit Ethernet uplink ports that require the installation of XENPAK transceivers and one 10/100/1000 port with an RJ-45 connector. All three uplink ports can be used at one time.

**Figure 2-4 Supervisor Engine 32 PISA (WS-S32-GE-PISA) Front Panel Features**

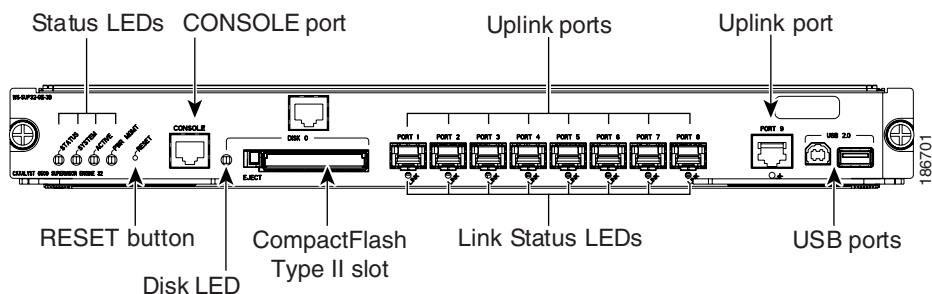

**Figure 2-5 Supervisor Engine 32 PISA (WS-S32-10GE-PISA) Front Panel Features**

Table 2-10 lists and describes Supervisor Engine 32 PISA features.

**Table 2-10 Supervisor Engine 32 PISA Features**

Feature	Description
Chassis compatibility	Supported on all Catalyst 6500 series chassis.
Software requirements (minimum)	<ul style="list-style-type: none"> <li>WS-S32-GE-PISA—12.2(18)ZY</li> <li>WS-S32-10GE-PISA—12.2(18)ZY1</li> </ul>
Fan tray requirements	<p>Both versions of Supervisor Engine 32 PISA require that a high-speed fan tray (either a fan tray 2 or Catalyst 6500-E series fan tray) be installed in the chassis. Low-speed fan trays do not provide sufficient cooling for Supervisor Engine 32 PISA.</p> <p><b>Note</b> The high-speed fan trays require that you install a 2500 W or higher capacity power supply in the chassis to power the fan tray.</p>
Slot installation restrictions	<p>Supervisor Engine 32 PISA must be installed in:</p> <ul style="list-style-type: none"> <li>Slots 1 and 2 in a 3-slot or a 4-slot chassis</li> <li>Slots 5 and 6 in a 6-slot or a 9-slot chassis</li> <li>Slots 7 and 8 in a 13-slot chassis</li> </ul> <p><b>Note</b> The primary supervisor engine can be installed in either slot.</p>
Backplane	<p>32-Gbps shared bus.</p> <p><b>Note</b> Supervisor Engine 32 PISA does not include and does not support switch fabric.</p>

Table 2-10 Supervisor Engine 32 PISA Features (continued)

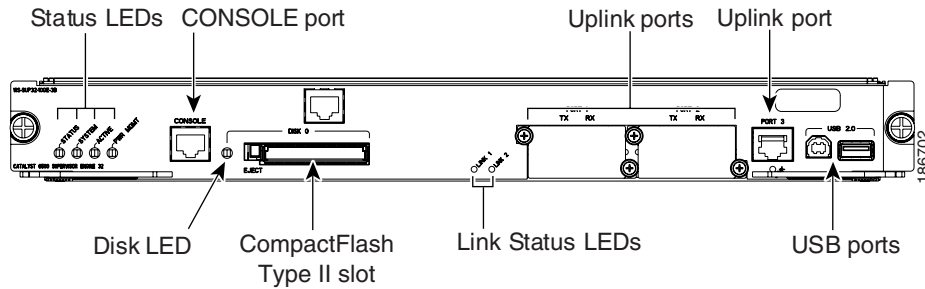
Feature	Description
Hardware restrictions	<p>Supervisor Engine 32 PISA does not support:</p> <ul style="list-style-type: none"> <li>• WS-F6K-PFC3A Policy Feature Card 3A (PFC3A)</li> <li>• WS-F6K-PFC3BXL Policy Feature Card 3BXL (PFC3BXL)</li> <li>• Distributed Forwarding Cards (DFCs).</li> </ul> <p><b>Note</b> Installed DFCs do not power up with Supervisor Engine 32 PISA.</p> <ul style="list-style-type: none"> <li>• Switch Fabric Modules (WS-C6500-SFM and WS-X6500-SFM2)</li> <li>• Ethernet modules not supported include: <ul style="list-style-type: none"> <li>– WS-X6704-10GE (4-port 10-Gigabit Ethernet module)</li> <li>– WS-X6748-SFP (48-port Gigabit Ethernet module)</li> <li>– WS-X6816-GBIC (16-port Gigabit Ethernet module)</li> <li>– WS-X6748-GE-TX (48-port 10/100/1000 Ethernet module)</li> </ul> </li> <li>• Optical Service Modules (OSMs)</li> <li>• WS-X6182-2PA FlexWAN module. (The WS-X6582-2PA Enhanced FlexWAN module is supported.)</li> <li>• Service modules not supported include: <ul style="list-style-type: none"> <li>– WS-SVC-WISM-1-K9 Wireless Services Module (WiSM)</li> <li>– WS-SVC-AON-1-K9 Application-Oriented Networking (AON) Module</li> <li>– WS-SVC-AGM-1-K9 Anomaly Guard Module</li> <li>– WS-SVC-ADM-1-K9 Traffic Anomaly Detector Module</li> <li>– WS-SVC-CSG-1 Content Services Gateway module</li> <li>– WS-X6066-SLB-APC Content Switching Module (CSM)</li> <li>– WS-X6066-SLB-S-K9 Content Switching Module with SSL (CSM-S)</li> <li>– WS-SVC-PSD-1 Persistent Storage Device (PSD) module</li> <li>– WS-SVC-WLAN-1-K9 Wireless LAN Services module</li> <li>– WS-SVC-IPSEC-1 IPsec VPN Accelerated Forwarding card</li> </ul> </li> </ul>

Table 2-10 Supervisor Engine 32 PISA Features (continued)

Feature	Description
Memory	
Switch Processor DRAM	<ul style="list-style-type: none"> <li>• 512 MB (WS-S32-GE-PISA)</li> <li>• 1 GB (WS-S32-10GE-PISA)</li> </ul>
Route Processor DRAM	1 GB
Switch Processor Bootflash/Bootdisk	512 MB through internal compact flash (bootdisk in CLI); upgradeable to 1 GB
Route Processor Bootflash	256 MB
CompactFlash (disk0)	Compact flash Type 2 (supports 64, 128, 256, 512 MB, and 1 GB)
Front panel features	
Status LEDs	See <a href="#">Table 2-12</a> for a list of the status LEDs and their descriptions.
RESET switch	<p>The RESET switch allows you to reset and restart the switch.</p> <p><b>Note</b> Because the reset switch is recessed in the faceplate, you must use a ballpoint pen tip or other small, pointed object to access the switch.</p>
CONSOLE port	This is a 10/100/1000 port that uses an RJ-45 connector. The CONSOLE port allows you to access the switch either locally (with a console terminal) or remotely (with a modem). The CONSOLE port is an EIA/TIA-232 asynchronous, serial connection with hardware flow control.
DISK 0 (PCMCIA) slot and LED	<p>One PCMCIA slot is available. The PCMCIA slot allows a Flash PC card to be installed providing additional flash memory. You can use this flash memory to store and run software images or to serve as an I/O device. An eject button is located on the left side, next to the slot. Pushing in on the button ejects the PCMCIA card from the slot.</p> <p>The PCMCIA slot has an LED associated with it.</p>

Table 2-10 Supervisor Engine 32 PISA Features (continued)

Feature	Description
Uplink ports (PORT 1 through PORT 9)	<ul style="list-style-type: none"> <li>The WS-S32-GE-PISA have nine uplink ports:               <ul style="list-style-type: none"> <li>Eight 1000BASE-X SFP ports and</li> <li>One 10/100/1000BASE RJ-45 port.</li> </ul>               All nine uplink ports can be used at one time.             </li> </ul> <p><b>Note</b> The eight 1000BASE-T or 1000BASE-X uplink ports require SFP transceivers to be installed.</p> <ul style="list-style-type: none"> <li>The WS-S32-10GE-PISA have three uplink ports:               <ul style="list-style-type: none"> <li>Two 10-Gigabit XENPAK ports</li> <li>One 10/100/1000BASE RJ-45 port.</li> </ul>               All three ports can be used at one time             </li> </ul> <p><b>Note</b> The two 10-Gigabit uplink ports require XENPAK transceivers to be installed.</p> <p><b>Note</b> In chassis configurations where there are redundant supervisor engines installed, the uplink ports on the supervisor engine that is in standby mode are fully functional.</p> <p>Each uplink port has a LINK LED associated with it.</p>
Unmarked RJ-45 port	The unmarked RJ-45 port, located above the PCMCIA slot, is currently not supported by the software and is disabled.
Universal Serial Bus (USB) port	Two USB 2.0 ports are provided. Currently, they are not enabled.
Uplink port queue structure (Tx/Rx)	1p3q8t/2q8t
Buffer size	<ul style="list-style-type: none"> <li>WS-S32-GE-PISA—9.5 MB per port</li> <li>WS-S32-10GE-PISA—100 MB per 10-gigabit port</li> </ul>
Pluggable transceivers supported	<ul style="list-style-type: none"> <li>WS-SUP32-GE-PISA—Eight 1-GB SFP transceivers are supported.</li> <li>WS-S32-10GE-PISA—Two 10-GB XENPAK transceivers are supported.</li> </ul> <p><b>Note</b> See Appendix A for a list and a description of the SFP and XENPAK transceivers that are supported.</p>
Hardware-based forwarding engine (Policy Feature Card)	<p>The PFC3B is installed on both versions of Supervisor Engine 32 PISA</p> <p><b>Note</b> The WS-F6K-PFC3A Policy Feature Card 3A (PFC3A) and the WS-F6K-PFC3BXL Policy Feature Card 3BXL (PFC3BXL) are not supported.</p>
Programmable IP Services Accelerator (PISA)	The PISA daughter card replaces the MSFC2A daughter card. The PISA daughter card integrates the MSFC2A functions and provides additional functionality.

Table 2-11 lists the physical and environmental specifications for Supervisor Engine 32 PISA.

**Table 2-11 Supervisor Engine 32 PISA Physical and Environmental Specifications**

Item	Specification
Dimensions (H x W x D)	1.6 x 15.3 x 16.3 in. (4.06 x 38.86 x 41.40 cm). Occupies one slot in the chassis.
Weight	WS-S32-GE-PISA—9.7 lb (4.4 kg) WS-S32-10GE-PISA—9.5 lb (4.3 kg)
Power requirement (at 42 VDC)	<ul style="list-style-type: none"> <li>WS-S32-GE-PISA—2.96 A</li> <li>WS-S32-10GE-PISA—2.97 A</li> </ul>
<b>Environment</b>	
Operating temperature	<ul style="list-style-type: none"> <li>Certified for operation: 32° to 104°F (0° to 40°C)</li> <li>Designed and tested for operation: 32° to 130°F (0° to 55°C)</li> </ul>
Humidity (RH) ambient (noncondensing)	10 to 90%
Operating altitude	<ul style="list-style-type: none"> <li>Certified for operation: 0 to 6500 feet (0 to 2000 m)</li> <li>Designed and tested for operation: -200 to 10,000 feet (-60 to 3000 m)</li> </ul>

Table 2-12 lists Supervisor Engine 32 PISA front panel LEDs and their meanings.

**Table 2-12 Supervisor Engine 32 PISA Front Panel Status LEDs**

LED	Color and Meaning
STATUS	<p>The STATUS LED indicates the status of the supervisor engine.</p> <ul style="list-style-type: none"> <li>Green—All diagnostics pass. The supervisor engine is operational (normal initialization sequence).</li> <li>Orange—The supervisor engine is booting or running diagnostics (normal initialization sequence) or an overtemperature condition has occurred. (A minor temperature threshold has been exceeded during environmental monitoring.)</li> <li>Red—The diagnostic test failed. The supervisor engine is not operational because a fault occurred during the initialization sequence or an overtemperature condition has occurred. (A major temperature threshold has been exceeded during environmental monitoring.)</li> </ul>
SYSTEM	<p>The SYSTEM LED indicates the status of the system components.</p> <ul style="list-style-type: none"> <li>Green—All chassis environmental monitors are reporting OK.</li> <li>Orange—A minor hardware problem has been detected.</li> <li>Red—A major hardware problem has occurred.</li> </ul>

Table 2-12 Supervisor Engine 32 PISA Front Panel Status LEDs (continued)

LED	Color and Meaning
ACTIVE	<p>The ACTIVE LED indicates whether the supervisor engine is operating in active mode or is in standby mode.</p> <ul style="list-style-type: none"> <li>Green—The supervisor engine is operational and active.</li> <li>Orange—The supervisor engine is in standby mode.</li> </ul>
PWR MGMT	<p>The supervisor engine monitors each module's power requirements and status relative to the system's overall power capacity before fully powering up each module in the chassis.</p> <ul style="list-style-type: none"> <li>Orange—Power-up mode; running self-diagnostics.</li> <li>Green—Power management is functioning normally and sufficient power is available for all modules.</li> <li>Orange—A minor power management problem has been detected. There is insufficient power for all modules to power up.</li> <li>Red—A major power failure has occurred.</li> </ul>
LINK	<p>The LINK LED indicates the link status of the corresponding port. For the eight SFP uplink ports plus the 10/100/1000 copper port, the LED colors indicate the following:</p> <ul style="list-style-type: none"> <li>Green—The port is active (the link is connected and operational).</li> <li>Flashing orange—The port failed diagnostics and is disabled.</li> <li>Orange—The port is disabled.</li> <li>Red—The supervisor engine is resetting; an overtemperature condition has occurred.</li> </ul> <p><b>Note</b> If the supervisor engine fails to download code and configuration information successfully during the initial reset, the LED stays red; the supervisor engine does not come online.</p> <p>Off—The port is not active or the link is not connected.</p> <p>For LINK LEDs associated with the XENPAK uplink ports, the LED colors indicate the following:</p> <ul style="list-style-type: none"> <li>Green—The XENPAK transceiver is installed, a network interface cable is attached, and a network link is established.</li> <li>Orange—The XENPAK transceiver is installed, the network interface cable is attached, but there is no network link established.</li> <li>Off—Either the uplink port socket is empty (no XENPAK transceiver is installed) or the XENPAK transceiver is installed, but does not have a network cable attached.</li> </ul>
DISK 0 (PCMCIA) LED	<p>Green—The installed Flash PC card is being accessed and is performing either a read or a write operation.</p>



# Supervisor Engine 720

Table 2-13 lists the available versions of Supervisor Engine 720 and provides a brief description of each. Figure 2-6 shows the faceplate of Supervisor Engine 720 with the major features identified.

**Table 2-13 Supervisor Engine 720 Versions**

Supervisor Engine 720 Product Numbers	Description
WS-SUP720	Supervisor Engine 720 (WS-SUP720) is shipped with a factory-installed PFC3A daughter card (WS-F6K-PFC3A) and a factory-installed MSFC3 daughter card (WS-F6K-MSFC3). Supervisor Engine 720 has three uplink ports: two 1000BASE-X Ethernet uplink ports that require the installation of GBIC transceivers and one 10/100/100 port equipped with an RJ-45 connector. Only two ports can be used at a time.
WS-SUP720-3B	Supervisor Engine 720 (WS-SUP720-3B) is shipped with a factory-installed PFC3B daughter card (WS-F6K-PFC3B) and a factory-installed MSFC3 daughter card (WS-F6K-MSFC3). Supervisor Engine 720 has three uplink ports: two 1000BASE-X Ethernet uplink ports that require the installation of GBIC transceivers and one 10/100/100 port equipped with an RJ-45 connector. Only uplink two ports can be used at a time.
WS-SUP720-3BXL	Supervisor Engine 720 (WS-SUP720-3BXL) is shipped with a factory-installed PFC3BXL daughter card (WS-F6K-PFC3BXL) and a factory-installed MSFC3 daughter card (WS-F6K-MSFC3). Supervisor Engine 720 has three uplink ports: two 1000BASE-X Ethernet uplink ports that require the installation of GBIC transceivers and one 10/100/100 port equipped with an RJ-45 connector. Only two uplink ports can be used at a time.

**Figure 2-6 Supervisor Engine 720 Front Panel Features**

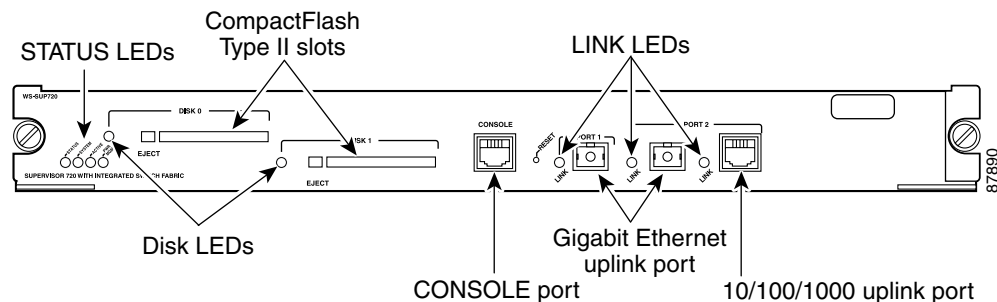

Table 2-14 lists and describes Supervisor Engine 720 features.

**Table 2-14 Supervisor Engine 720 Features**

Feature	Description
Chassis compatibility	Supported on all Catalyst 6500 series chassis.
Software requirements (minimum)	<ul style="list-style-type: none"> <li>Supervisor Engine 720—12.2(14)SX</li> <li>Supervisor Engine 720-3B—12.2(17d)SXB1</li> <li>Supervisor Engine 720-3BXL—12.2(17b)SXA</li> </ul>
Fan tray requirements	<p>All versions of Supervisor Engine 720 require that a high-speed fan tray (either a fan tray 2 or Catalyst 6500-E series fan tray) be installed in the chassis.</p> <p><b>Note</b> Low-speed fan trays do not provide sufficient cooling for Supervisor Engine 720.</p>
Slot installation restrictions	<p>Supervisor Engine 720 must be installed in:</p> <ul style="list-style-type: none"> <li>Slots 1 and 2 in a 3-slot or a 4-slot chassis</li> <li>Slots 5 and 6 in a 6-slot or a 9-slot chassis</li> <li>Slots 7 and 8 in a 13-slot chassis</li> </ul> <p><b>Note</b> The primary supervisor engine can be installed in either slot.</p>
Backplane	<p>32-Gbps shared bus</p> <p>Integrated 720-Gbps Switch Fabric</p>
Hardware restrictions	There are no additional hardware restrictions for Supervisor Engine 720.
Memory	
Switch Processor DRAM	<ul style="list-style-type: none"> <li>512 MB (WS-SUP720)</li> <li>512 MB (WS-SUP720-3B)</li> <li>1 GB (WS-SUP720-3BXL)</li> </ul>
Route Processor DRAM	<ul style="list-style-type: none"> <li>512 MB (WS-SUP720)</li> <li>512 MB (WS-SUP720-3B)</li> <li>1 GB (WS-SUP720-3BXL)</li> </ul>
Switch Processor Bootflash/Bootdisk	<p>For all three Supervisor Engine 720 models:</p> <ul style="list-style-type: none"> <li>64 MB (before May 5, 2006)</li> <li>512 MB (after May 5, 2006)</li> </ul> <p><b>Note</b> Use upgrade kit WS-CF-UPG= to upgrade the bootflash from 64 MB to 512 MB.</p>
Route Processor Bootflash CompactFlash (disk0)	<p>For all three Supervisor Engine 720 models—64 MB</p> <p>Compact flash Type 2 (supports 64, 128, 256, 512 MB, and 1 GB)</p>

Table 2-14 Supervisor Engine 720 Features (continued)

Feature	Description
Front panel features	
Status LEDs	See Table 2-16 for a list of the status LEDs and their descriptions.
RESET switch	<p>The RESET switch allows you to reset and restart the switch.</p> <p><b>Note</b> Because the reset switch is recessed in the faceplate, you must use a ballpoint pen tip or other small, pointed object to access the switch.</p>
CONSOLE port	This is a 10/100/1000 port that uses an RJ-45 connector. The CONSOLE port allows you to access the switch either locally (with a console terminal) or remotely (with a modem). The CONSOLE port is an EIA/TIA-232 asynchronous, serial connection with hardware flow control.
DISK 0 and DISK 1 slot and LEDs	<p>Two PCMCIA slots are available. The PCMCIA slots allow a Flash PC card to be installed providing additional flash memory. You can use this flash memory to store and run software images or to serve as an I/O device. An eject button is located on the left side, next to each slot. Pushing in on the button ejects the Flash PC card from the slot. The slot supports 64, 128, 256, 512 MB, and 1 GB Flash PC cards.</p> <p>Each PCMCIA slot has an LED associated with it.</p>
Uplink ports (PORT 1 and PORT 2)	<ul style="list-style-type: none"> <li>• Supervisor Engine 720 has three uplink ports: Two 1000BASE-X SFP ports and one 10/100/1000BASE RJ-45 port. Only two ports can be active at one time.</li> </ul> <p><b>Note</b> The two 1000BASE-T or 1000BASE-X uplink ports require SFP transceivers to be installed.</p> <p><b>Note</b> In chassis configurations where there are redundant supervisor engines installed, the uplink ports on the supervisor engine that is in standby mode are fully functional.</p> <p>Each uplink port has a LINK LED associated with it. The LINK LED indicates the link status of the corresponding port.</p> <ul style="list-style-type: none"> <li>• Green—The port is active (the link is connected and operational).</li> <li>• Flashing orange—The port failed diagnostics and is disabled.</li> <li>• Orange—The port is disabled.</li> <li>• Red—The supervisor engine is resetting; an overtemperature condition has occurred.</li> </ul> <p><b>Note</b> If the supervisor engine fails to download code and configuration information successfully during the initial reset, the LED stays red; the supervisor engine does not come online.</p> <ul style="list-style-type: none"> <li>• Off—The port is not active or the link is not connected.</li> </ul>

**Table 2-14** Supervisor Engine 720 Features (continued)

Feature	Description
Uplink port queue structure	<ul style="list-style-type: none"> <li>Tx—1p2q2t</li> <li>Rx—1p1q4t</li> </ul>
Buffer size	<ul style="list-style-type: none"> <li>Total buffer size—512 KB</li> <li>Rx/Tx buffer size—80 KB/432 KB</li> </ul>
Pluggable transceivers supported	<p>Supports SFP transceivers in the uplink ports.</p> <p><b>Note</b> See Appendix A for a list and a description of the SFP transceivers that are supported.</p>
Hardware-based forwarding engine (Policy Feature Card)	<ul style="list-style-type: none"> <li>WS-SUP720—PFC3A (WS-F6K-PFC3A)</li> <li>WS-SUP720-3B—PFC3B (WS-F6K-PFC3B)</li> <li>WS-SUP720-3BXL—PFC3BXL (WS-F6K-PFC3BXL)</li> </ul>
Multilayer Switch Feature Card (MSFC) daughter card version installed	<ul style="list-style-type: none"> <li>MSFC3 (WS-F6K-MSFC3) on all Supervisor Engine 720 versions.</li> </ul>

Table 2-15 lists Supervisor Engine 720 physical and environmental specifications.

**Table 2-15** Supervisor Engine 720 Physical and Environmental Specifications

Item	Specification
Dimensions (H x W x D)	1.6 x 15.3 x 16.3 in. (4.06 x 38.86 x 41.40 cm). Occupies one slot in the chassis.
Weight	<ul style="list-style-type: none"> <li>WS-SUP720—11.5 lb</li> <li>WS-SUP720-3B—11.6 lb</li> <li>WS-SUP720-3BXL—11.8 lb</li> </ul>
Power requirement (at 42 VDC)	<ul style="list-style-type: none"> <li>WS-SUP720—7.5 A</li> <li>WS-SUP720-3B—6.72 A</li> <li>WS-SUP720-3BXL—7.82 A</li> </ul>
<b>Environment</b>	
Operating temperature	<ul style="list-style-type: none"> <li>Certified for operation: 32° to 104°F (0° to 40°C)</li> <li>Designed and tested for operation: 32° to 130°F (0° to 55°C)</li> </ul>
Humidity (RH) ambient (noncondensing)	10 to 90%
Operating altitude	<ul style="list-style-type: none"> <li>Certified for operation: 0 to 6500 feet (0 to 2000 meters)</li> <li>Designed and tested for operation: -200 to 10,000 feet (-60 to 3000 meters)</li> </ul>

Table 2-16 lists Supervisor Engine 720 front panel LEDs and their meanings.

**Table 2-16 Supervisor Engine 720 Front Panel Status LEDs**

LED	Color and Meaning
STATUS	<p>The STATUS LED indicates the status of the supervisor engine.</p> <ul style="list-style-type: none"> <li>• Green—All diagnostics pass. The supervisor engine is operational (normal initialization sequence).</li> <li>• Orange—The supervisor engine is booting or running diagnostics (normal initialization sequence) or an overtemperature condition has occurred. (A minor temperature threshold has been exceeded during environmental monitoring.)</li> <li>• Red—The diagnostic test failed. The supervisor engine is not operational because a fault occurred during the initialization sequence or an overtemperature condition has occurred. (A major temperature threshold has been exceeded during environmental monitoring.)</li> </ul>
SYSTEM	<p>The SYSTEM LED indicates the status of the system components.</p> <ul style="list-style-type: none"> <li>• Green—All chassis environmental monitors are reporting OK.</li> <li>• Orange—A minor hardware problem has been detected.</li> <li>• Red—A major hardware problem has occurred</li> </ul>
ACTIVE	<p>The ACTIVE LED indicates whether the supervisor engine is operating in active mode or is in standby mode.</p> <ul style="list-style-type: none"> <li>• Green—The supervisor engine is operational and active.</li> <li>• Orange—The supervisor engine is in standby mode.</li> </ul>
PWR MGMT	<p>The supervisor engine monitors each module's power requirements and status relative to the system's overall power capacity before fully powering up each module in the chassis.</p> <ul style="list-style-type: none"> <li>• Orange—Power-up mode; running self-diagnostics.</li> <li>• Green—Power management is functioning normally and sufficient power is available for all modules.</li> <li>• Orange—A minor power management problem has been detected. There is insufficient power for all modules to power up.</li> <li>• Red—A major power failure has occurred.</li> </ul>
DISK 0 and DISK 1 LEDs	<p>These LEDs are illuminated green when the installed Flash PC card is being accessed and is performing either a read operation or a write operation.</p>

# Supervisor Engine 720-10GE

Table 2-17 lists the available versions of Supervisor Engine 720-10GE and provides a brief description of each. Figure 2-7 shows the faceplate of Supervisor Engine 720-10GE with the major features identified.

**Table 2-17 Supervisor Engine 720-10GE Models**

Supervisor Engine 720 Product Numbers	Description
Supervisor Engine 720-10GE (VS-S720-10G-3C)	Supervisor Engine 720 (VS-S720-10G-3C) is shipped with a factory-installed PFC3C daughter card (WS-F6K-PFC3C) and a factory-installed MSFC3 daughter card (WS-F6K-MSFC3). Supervisor Engine 720 has five uplink ports: two 10GBASE-X Ethernet ports that require the installation of X2 transceivers, two 1000BASE-X Ethernet ports that require SFP transceivers, and one 10/100/100 port equipped with an RJ-45 connector.
Supervisor Engine 720-10GE (VS-S720-10G-3CXL)	Supervisor Engine 720 (VS-S720-10G-3CXL) is shipped with a factory-installed PFC3CXL daughter card (WS-F6K-PFC3CXL) and a factory-installed MSFC3 daughter card (WS-F6K-MSFC3). Supervisor Engine 720-10GE has five uplink ports: two 10GBASE-X Ethernet ports that require the installation of X2 transceivers, two 1000BASE-X Ethernet ports that require SFP transceivers, and one 10/100/100 port equipped with an RJ-45 connector.

**Figure 2-7 Supervisor Engine 720-10GE Front Panel Features**

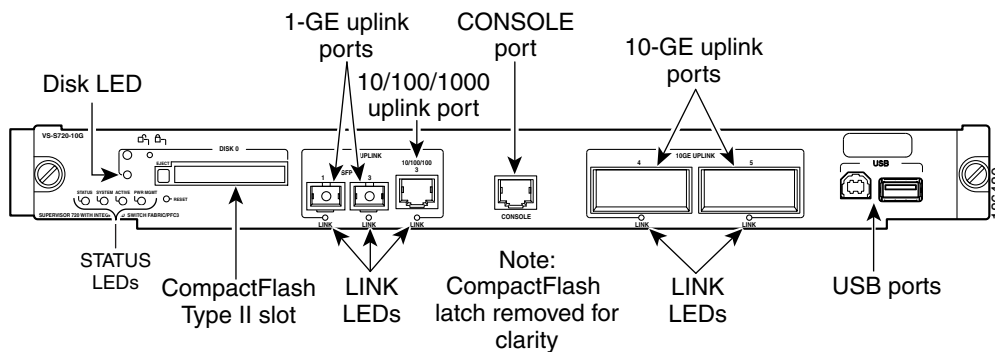

Table 2-18 lists and describes Supervisor Engine 720-10GE features.

**Table 2-18 Supervisor Engine 720-10GE Features**

Feature	Description
Chassis compatibility	Supported on all Catalyst 6500 series chassis.
Software requirements (minimum)	12.2(33)SHX <b>Note</b> If there are no DFC-equipped modules installed, certain configurations require Release 12.2(33)SXH1 or later and impose configuration restrictions. Refer to your software release notes for further information.
Fan tray requirements	All versions of Supervisor Engine 720-10GE require that a high-speed fan tray (either a fan tray 2 or Catalyst 6500-E series fan tray) be installed in the chassis. <b>Note</b> Low-speed fan trays do not provide sufficient cooling for Supervisor Engine 720-10GE.
Slot installation restrictions	Supervisor Engine 720-10GE must be installed in: <ul style="list-style-type: none"> <li>• Slots 1 and 2 in a 3-slot or a 4-slot chassis</li> <li>• Slots 5 and 6 in a 6-slot or a 9-slot chassis</li> <li>• Slots 7 and 8 in a 13-slot chassis</li> </ul> <b>Note</b> The primary supervisor engine can be installed in either slot.
Backplane	32-Gbps shared bus Integrated 720-Gbps Switch Fabric
Hardware restrictions	There are no additional hardware restrictions for Supervisor Engine 720-10GE.

Table 2-18 Supervisor Engine 720-10GE Features (continued)

Feature	Description
Memory	
Switch Processor DRAM	1 GB
Route Processor DRAM	1 GB
Switch Processor	1 GB
Bootflash/Bootdisk	
Route Processor Bootflash	64 MB
CompactFlash (disk0)	Compact flash Type 2 (supports 64, 128, 256, 512 MB, and 1 GB)
Front panel features	
Status LEDs	See <a href="#">Table 2-20</a> for a list of the status LEDs and their descriptions.
RESET switch	The RESET switch allows you to reset and restart the switch.  <b>Note</b> Because the reset switch is recessed in the faceplate, you must use a ballpoint pen tip or other small, pointed object to access the switch.
CONSOLE port	This is a 10/100/1000 port that uses an RJ-45 connector. The CONSOLE port allows you to access the switch either locally (with a console terminal) or remotely (with a modem). The CONSOLE port is an EIA/TIA-232 asynchronous, serial connection with hardware flow control.
Universal Serial Bus (USB) port	Two USB 2.0 ports are provided. Currently, they are not enabled.
DISK 0 slot and LED	One PCMCIA slot is available. The PCMCIA slots allow a Flash PC card to be installed providing additional flash memory. You can use this flash memory to store and run software images or to serve as an I/O device. An eject button is located on the left side, next to each slot. Pushing in on the button ejects the Flash PC card from the slot. The slot supports 256 MB, 512 MB, and 1 GB Flash PC cards.  The PCMCIA slot has an LED associated with it.
Uplink ports (PORT 1 through PORT 5)	<ul style="list-style-type: none"> <li>• Supervisor Engine 720-10GE has five uplink ports: <ul style="list-style-type: none"> <li>– Two 10GBASE-X ports</li> <li>– Two 1000BASE-X ports</li> <li>– One 10/100/1000BASE RJ-45 port</li> </ul> </li> </ul> <p><b>Note</b> The two 10GBASE-X ports require X2 transceiver modules; the two 1000BASE-X uplink ports require SFP transceiver modules.</p> <p><b>Note</b> In chassis configurations where there are redundant supervisor engines installed, the uplink ports on the supervisor engine that is in standby mode are fully functional.</p> <ul style="list-style-type: none"> <li>• Each uplink port has a link LED associated with it.</li> </ul>



**Table 2-18** Supervisor Engine 720-10GE Features (continued)

Feature	Description
Uplink port queue structure	<ul style="list-style-type: none"> <li>• 1000BASE-X (uplink ports 1 and 2) <ul style="list-style-type: none"> <li>– Tx—1p3q4t</li> <li>– Rx—2q4t</li> </ul> </li> <li>• 10/100/1000 Mbps (uplink port 3) <ul style="list-style-type: none"> <li>– Tx—1p3q4t</li> <li>– Rx—2q4t</li> </ul> </li> <li>• 10GBASE-X (uplink ports 4 and 5) (1000BASE-X ports inactive) <ul style="list-style-type: none"> <li>– Tx—1p7q4t</li> <li>– Rx—8q4t (VS-S720-10G-3C); 2q8t (VS-S720-10G-3CXL)</li> </ul> </li> <li>• 10GBASE-X (uplink ports 4 and 5) (1000BASE-X ports active) <ul style="list-style-type: none"> <li>– Tx—1p3q4t</li> <li>– Rx—2q4t</li> </ul> </li> </ul>
Buffer size	<ul style="list-style-type: none"> <li>• 10GBASE port—191.8 MB per port</li> <li>• 1000BASE port—17.7 MB per port</li> </ul>
Pluggable transceivers supported	<ul style="list-style-type: none"> <li>• Supports SFP 1-GBASE-X transceivers in Ports 1 and 2.</li> <li>• Supports X2 10-GBASE-X transceivers in Ports 4 and 5.</li> </ul> <p><b>Note</b> See Appendix A for a list and a description of the X2 and SFP transceivers that are supported.</p>
Hardware-based forwarding engine (Policy Feature Card)	<ul style="list-style-type: none"> <li>• VS-S720-10G-3C—PFC3C (WS-F6K-PFC3C)</li> <li>• VS-S720-10G-3CXL—PFC3CXL (WS-F6K-PFC3CXL)</li> </ul>
Multilayer Switch Feature Card (MSFC) daughter card version installed	<ul style="list-style-type: none"> <li>• MSFC3 (WS-F6K-MSFC3)</li> </ul>

Table 2-19 lists the physical and environmental specifications for Supervisor Engine 720-10GE.

**Table 2-19 Supervisor Engine 720-10GE Physical and Environmental Specifications**

Item	Specification
Dimensions (H x W x D)	1.6 x 15.3 x 16.3 in. (4.06 x 38.86 x 41.40 cm). Occupies one slot in the chassis.
Weight	11.5 lb (5.22 kg)
Power requirement (at 42 VDC)	<ul style="list-style-type: none"> <li>Supervisor Engine 720-10G (VS-S720-10G-3C)—8.05 A</li> <li>Supervisor Engine 720-10G (VS-S720-10G-3CXL)—8.65 A</li> </ul>
<b>Environment</b>	
Operating temperature	<ul style="list-style-type: none"> <li>Certified for operation: 32° to 104°F (0° to 40°C)</li> <li>Designed and tested for operation: 32° to 130°F (0° to 55°C)</li> </ul>
Humidity (RH) ambient (noncondensing)	10 to 90%
Operating altitude	<ul style="list-style-type: none"> <li>Certified for operation: 0 to 6500 feet (0 to 2000 m)</li> <li>Designed and tested for operation: -200 to 10,000 feet (-60 to 3000 m)</li> </ul>

Table 2-20 lists Supervisor Engine 720-10GE front panel LEDs and their meanings.

**Table 2-20 Supervisor Engine 720-10GE Front Panel Status LEDs**

LED	Color and Meaning
STATUS	<p>The STATUS LED indicates the status of the supervisor engine.</p> <ul style="list-style-type: none"> <li>• Green—All diagnostics pass. The supervisor engine is operational (normal initialization sequence).</li> <li>• Orange—The supervisor engine is booting or running diagnostics (normal initialization sequence) or an overtemperature condition has occurred. (A minor temperature threshold has been exceeded during environmental monitoring.)</li> <li>• Red—The diagnostic test failed. The supervisor engine is not operational because a fault occurred during the initialization sequence or an overtemperature condition has occurred. (A major temperature threshold has been exceeded during environmental monitoring.)</li> </ul>
SYSTEM	<p>The SYSTEM LED indicates the status of the system components.</p> <ul style="list-style-type: none"> <li>• Green—All chassis environmental monitors are reporting OK.</li> <li>• Orange—A minor hardware problem has been detected.</li> <li>• Red—A major hardware problem has occurred.</li> </ul>
ACTIVE	<p>The ACTIVE LED indicates whether the supervisor engine is operating in active mode or is in standby mode.</p> <ul style="list-style-type: none"> <li>• Green—The supervisor engine is operational and active.</li> <li>• Orange—The supervisor engine is in standby mode.</li> </ul>
PWR MGMT	<p>The supervisor engine monitors each module's power requirements and status relative to the system's overall power capacity before fully powering up each module in the chassis.</p> <ul style="list-style-type: none"> <li>• Orange—Power-up mode; running self-diagnostics.</li> <li>• Green—Power management is functioning normally and sufficient power is available for all modules.</li> <li>• Orange—A minor power management problem has been detected. There is insufficient power for all modules to power up.</li> <li>• Red—A major power failure has occurred.</li> </ul>

**Table 2-20 Supervisor Engine 720-10GE Front Panel Status LEDs (continued)**

<b>LED</b>	<b>Color and Meaning</b>
DISK 0	This LED is illuminated green when the installed Flash PC card is being accessed and is performing either a read operation or a write operation.
LINK	<p>Each uplink port has a LINK LED associated with it. The LINK LED indicates the link status of the corresponding port.</p> <ul style="list-style-type: none"> <li>• Green—The port is active (the link is connected and operational).</li> <li>• Flashing orange—The port failed diagnostics and is disabled.</li> <li>• Orange—The port is disabled.</li> <li>• Red—The supervisor engine is resetting; an overtemperature condition has occurred.</li> </ul> <p><b>Note</b> If the supervisor engine fails to download code and configuration information successfully during the initial reset, the LED stays red; the supervisor engine does not come online.</p> <ul style="list-style-type: none"> <li>• Off—The port is not active or the link is not connected.</li> </ul>

# Supervisor Engine 2T

Table 2-21 lists the available versions of Supervisor Engine 2T and provides a brief description of each. Figure 2-8 shows the faceplate of Supervisor Engine 2T with the major features identified.

**Table 2-21 Supervisor Engine 2T Models**

Supervisor Engine 720 Product Numbers	Description
VS-S2T-10G	The VS-S2T-10G is shipped with a factory-installed PFC4 daughter card (VS-F6K-PFC4) and a factory-installed MSFC5 daughter card (VS-F6K-MSFC5). There are five uplink ports: two 10GBASE-X Ethernet ports that require the installation of X2 transceivers and three 1000BASE-X Ethernet ports that require SFP transceivers.
VS-S2T-10G-XL	The VS-S2T-10G-XL is shipped with a factory-installed PFC4XL daughter card (VS-F6K-PFC4XL) and a factory-installed MSFC5 daughter card (VS-F6K-MSFC5). There are five uplink ports: two 10GBASE-X Ethernet ports that require the installation of X2 transceivers and three 1000BASE-X Ethernet ports that require SFP transceivers.

**Figure 2-8 Supervisor Engine 2T Front Panel Features**

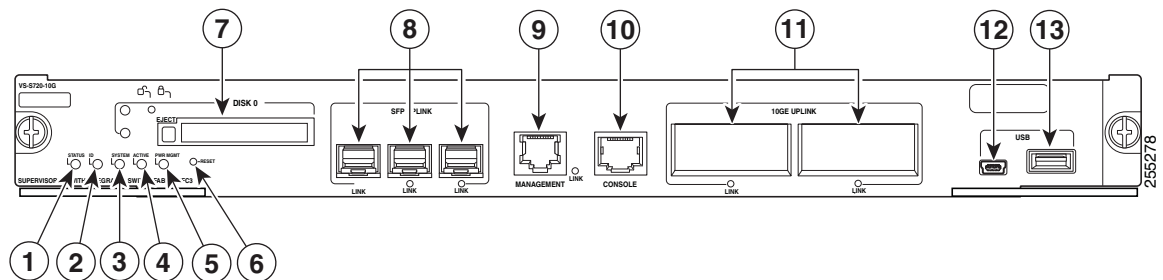

1	STATUS LED	8	1000BASE-X UPLINK ports (requires SFP transceivers)
2	ID LED	9	MANAGEMENT port
3	SYSTEM LED	10	CONSOLE port
4	ACTIVE LED	11	10GBASE-X UPLINK ports (requires X2 transceivers)
5	PWR MGMT LED	12	USB port
6	RESET switch	13	Port currently not supported
7	PCMCIA slot		

Table 2-22 lists and describes Supervisor Engine 2T features.

**Table 2-22 Supervisor Engine 2T Features**

Feature	Description
Chassis compatibility	Supported only on all Catalyst 6500 E-series chassis.
Software requirements (minimum)	12.2(50)SY
Fan tray requirements	Both versions of the Supervisor Engine 2T require that a high-speed fan tray be installed in the chassis. <b>Note</b> Low-speed fan trays do not provide sufficient cooling for Supervisor Engine 2T.
Slot installation restrictions	Supervisor Engine 2T must be installed in: <ul style="list-style-type: none"> <li>• Slots 1 and 2 in a 3-slot or a 4-slot chassis</li> <li>• Slots 5 and 6 in a 6-slot or a 9-slot chassis</li> <li>• Slots 7 and 8 in a 13-slot chassis</li> </ul> <b>Note</b> The primary supervisor engine can be installed in either slot. <b>Note</b> When the Supervisor Engine 2T is installed in a chassis with either a WS-X69xx or a WS-X68xx module, there is a requirement that the two slots adjacent to the supervisor engine and the module either have a module installed in them or, if the slots are unused, have a switching-module filler plate (Cisco part number SLOTBLANK-09 or WS-X6K-SLOT-CVR-E) installed for NEBS compliance. Do not use blank slot covers (WS-X6K-SLOT-CVR) to cover the adjacent unused slots.
Hardware restrictions	<ul style="list-style-type: none"> <li>• Supported only in Catalyst 6500 E-series switches.</li> <li>• Supports only modules equipped with the DFC4-A, DFC4-AXL, DFC4-E, DFC4-EXL, or the CFC daughter cards. Modules equipped with DFC3 daughter cards are not supported. For further information on hardware restrictions and module support, refer to the software release notes at the following URL: <a href="http://www.cisco.com/en/US/docs/switches/lan/catalyst6500/ios/12.2SY/release/notes/ol_20679.html">http://www.cisco.com/en/US/docs/switches/lan/catalyst6500/ios/12.2SY/release/notes/ol_20679.html</a></li> </ul>

Table 2-22 Supervisor Engine 2T Features (continued)

Feature	Description
Memory	
DRAM	2 GB
External CompactFlash (disk0)	Compact flash Type 2 (1 GB)
Front panel features	
Status LEDs	See <a href="#">Table 2-24</a> for a list of the status LEDs and their descriptions.
RESET switch	The RESET switch allows you to reset and restart the switch.  <b>Note</b> Because the reset switch is recessed in the supervisor engine faceplate, you must use a ballpoint pen tip or other small, pointed object to access the switch.
CONSOLE port	This is a 10/100/1000 port that uses an RJ-45 connector. The CONSOLE port allows you to access the switch either locally (with a console terminal) or remotely (with a modem). The CONSOLE port is an EIA/TIA-232 asynchronous, serial connection with hardware flow control.
Universal Serial Bus (USB) port	Two USB 2.0 ports are provided. The USB 5-pin mini Type-B connector is used as a console port allowing attachment to PCs that are not equipped with an RS-232 interface. The second USB port is currently not supported.
MANAGEMENT port	A 10/100/1000 copper port used for out-of-band Ethernet management of the switch.
DISK 0 slot and LED	One PCMCIA slot is available. The PCMCIA slots allow a Flash PC card to be installed providing additional flash memory. You can use this flash memory to store and run software images or to serve as an I/O device. An eject button is located on the left side, next to each slot. Pushing in on the button ejects the Flash PC card from the slot. The slot supports 1 GB Flash PC cards.  The PCMCIA slot has an activity LED associated with it.
Uplink ports (PORT 1 through PORT 5)	<ul style="list-style-type: none"> <li>• Supervisor Engine 2T has five uplink ports: <ul style="list-style-type: none"> <li>– Two 10GBASE-X ports</li> <li>– Three 1000BASE-X ports</li> </ul> </li> </ul> <p><b>Note</b> The two 10GBASE-X ports require X2 transceiver modules; the three 1000BASE-X uplink ports require SFP transceiver modules. For X2 and SFP transceiver support, refer to the compatibility matrices at the following URL:</p> <p style="text-align: center;"><a href="http://www.cisco.com/en/US/products/hw/modules/ps5455/products_device_support_tables_list.html">http://www.cisco.com/en/US/products/hw/modules/ps5455/products_device_support_tables_list.html</a></p> <p><b>Note</b> In chassis configurations where there are redundant supervisor engines installed, the uplink ports on the supervisor engine that is in standby mode are fully functional.</p> <ul style="list-style-type: none"> <li>• Each uplink port has a link LED associated with it.</li> </ul>

Table 2-22 Supervisor Engine 2T Features (continued)

Feature	Description
Uplink port queue structure	<ul style="list-style-type: none"> <li>• 1000BASE-X (uplink ports 1, 2, and 3) <ul style="list-style-type: none"> <li>– Tx—1p3q4t</li> <li>– Rx—2q4t</li> </ul> </li> <li>• 10GBASE-X (uplink ports 4 and 5) <ul style="list-style-type: none"> <li>– With ports 1, 2, and 3 enabled: Tx—1p3q4t, Rx—2q4t</li> <li>– With ports 1, 2, and 3 disabled: Tx—1p7q4t, Rx—8q4t</li> </ul> </li> <li>• 1 port group</li> </ul>
Pluggable transceivers supported	<ul style="list-style-type: none"> <li>• Supports SFP 1000BASE-X transceivers in Ports 1, 2, and 3.</li> <li>• Supports X2 10-GBASE-X transceivers in Ports 4 and 5.</li> </ul> <p><b>Note</b> For additional information about SFP and X2 transceiver support, see the compatibility matrices listed on this page:</p> <p><a href="http://www.cisco.com/en/US/products/hw/modules/ps5455/products_device_support_tables_list.html">http://www.cisco.com/en/US/products/hw/modules/ps5455/products_device_support_tables_list.html</a></p> <p>Also see Appendix A for descriptions of the X2 and SFP transceivers.</p>
Hardware-based forwarding engine (Policy Feature Card)	<ul style="list-style-type: none"> <li>• VS-S2T-10G—PFC4 (VS-F6K-PFC4)</li> <li>• VS-S2T-10G-XL—PFC4XL (VS-F6K-PFC4XL)</li> </ul>
Multilayer Switch Feature Card (MSFC) daughter card version installed	MSFC5 (VS-F6K-MSFC5)



Table 2-23 lists the physical and environmental specifications for Supervisor Engine 2T.

**Table 2-23 Supervisor Engine 2T Physical and Environmental Specifications**

Item	Specification
Dimensions (H x W x D)	1.73 x 14.4 x 16.0 in. (4.4 x 36.6 x 40.6 cm). Occupies one slot in the chassis.
Weight	12.0 lb (5.44 kg)
Power requirement (at 42 VDC)	<ul style="list-style-type: none"> <li>• VS-S2T-10G—10.36 A</li> <li>• VS-S2T-10G-XL—10.71 A</li> </ul>
<b>Environment</b>	
Operating temperature	<ul style="list-style-type: none"> <li>• Certified for operation: 32° to 104°F (0° to 40°C)</li> <li>• Designed and tested for operation: 32° to 130°F (0° to 55°C)</li> </ul>
Humidity (RH) ambient (noncondensing)	10 to 90%
Operating altitude	<ul style="list-style-type: none"> <li>• Certified for operation: 0 to 6500 feet (0 to 2000 m)</li> <li>• Designed and tested for operation: -200 to 10,000 feet (-60 to 3000 m)</li> </ul>

Table 2-20 lists Supervisor Engine 2T front panel LEDs and their meanings.

**Table 2-24 Supervisor Engine 2T Front Panel Status LEDs**

LED	Color and Meaning
STATUS	<p>The STATUS LED indicates the status of the supervisor engine.</p> <ul style="list-style-type: none"> <li>• Green—All diagnostics pass. The supervisor engine is operational (normal initialization sequence).</li> <li>• Orange—The supervisor engine is booting or running diagnostics (normal initialization sequence) or an overtemperature condition has occurred. (A minor temperature threshold has been exceeded during environmental monitoring.)</li> <li>• Red—The diagnostic test failed. The supervisor engine is not operational because a fault occurred during the initialization sequence or an overtemperature condition has occurred. (A major temperature threshold has been exceeded during environmental monitoring.)</li> </ul>
ID	<p>A blue LED that flashes at half-second intervals is used to identify the supervisor engine for servicing purposes.</p>
SYSTEM	<p>The SYSTEM LED indicates the status of the system components.</p> <ul style="list-style-type: none"> <li>• Green—All chassis environmental monitors are reporting OK.</li> <li>• Orange—A minor hardware problem has been detected.</li> <li>• Red—A major hardware problem has occurred.</li> </ul>
ACTIVE	<p>The ACTIVE LED indicates whether the supervisor engine is operating in active mode or is in standby mode.</p> <ul style="list-style-type: none"> <li>• Green—The supervisor engine is operational and active.</li> <li>• Orange—The supervisor engine is in standby mode.</li> </ul>
PWR MGMT	<p>The supervisor engine monitors each module's power requirements and status relative to the system's overall power capacity before fully powering up each module in the chassis.</p> <ul style="list-style-type: none"> <li>• Orange—Power-up mode; running self-diagnostics.</li> <li>• Green—Power management is functioning normally and sufficient power is available for all modules.</li> <li>• Orange—A minor power management problem has been detected. There is insufficient power for all modules to power up.</li> <li>• Red—A major power failure has occurred.</li> </ul>
DISK 0	<p>This LED is illuminated green when the installed Flash PC card is being accessed and is performing either a read operation or a write operation.</p>

**Table 2-24 Supervisor Engine 2T Front Panel Status LEDs (continued)**

<b>LED</b>	<b>Color and Meaning</b>
LINK (SFP UPLINK)	<p>Each of the three SFP uplink ports has a LINK LED associated with it. The LINK LED indicates the link status of the corresponding port.</p> <ul style="list-style-type: none"> <li>• Green—The port is active (the link is connected and operational).</li> <li>• Flashing orange—The port failed diagnostics and is disabled.</li> <li>• Orange—The port is disabled.</li> <li>• Red—The supervisor engine is resetting; an overtemperature condition has occurred.</li> </ul> <p><b>Note</b> If the supervisor engine fails to download code and configuration information successfully during the initial reset, the LED stays red; the supervisor engine does not come online.</p> <ul style="list-style-type: none"> <li>• Off—The port is not active or the link is not connected.</li> </ul>
MANAGEMENT port	<p>The 10/100/1000 management port has an green LED associated with it.</p> <ul style="list-style-type: none"> <li>• Green—The port is active (the link is connected and operational).</li> <li>• Off—The port is not active or the link is not connected.</li> </ul>
LINK (10GE UPLINK)	<p>Each of the two 10GE uplink ports have a link LED associated with it.</p> <ul style="list-style-type: none"> <li>• Green—The port is active (the link is connected and operational).</li> <li>• Flashing orange—The port failed diagnostics and is disabled.</li> <li>• Orange—The port is disabled.</li> <li>• Red—The supervisor engine is resetting; an overtemperature condition has occurred.</li> </ul> <p><b>Note</b> If the supervisor engine fails to download code and configuration information successfully during the initial reset, the LED stays red; the supervisor engine does not come online.</p> <p>Off—The port is not active or the link is not connected.</p>





# CHAPTER 3

## Installing Supervisor Engines

---

**Revised: July 2011**

This chapter describes how to safely install and remove supervisor engine modules in the Catalyst 6500 series switches, and it contains these sections:

- [Safety, page 3-1](#)
- [Required Tools, page 3-2](#)
- [Installing a Supervisor Engine, page 3-2](#)
- [Removing a Supervisor Engine, page 3-10](#)
- [Installing Pluggable Transceivers, page 3-17](#)
- [Attaching the Network Interface Cables, page 3-17](#)
- [Where to Go Next, page 3-22](#)



**Tip**

---

For additional information about Cisco Catalyst 6500 Series Switches (including configuration examples and troubleshooting information), see the documents listed on this page:

[http://www.cisco.com/en/US/products/hw/switches/ps708/tsd\\_products\\_support\\_series\\_home.html](http://www.cisco.com/en/US/products/hw/switches/ps708/tsd_products_support_series_home.html)

---

## Safety

Safety warnings appear throughout this publication in procedures that may harm you if performed incorrectly. A warning symbol precedes each warning statement. The warnings below are general warnings that are applicable to the entire publication.



**Warning**

---

**Only trained and qualified personnel should be allowed to install, replace, or service this equipment.** Statement 1030

---



**Warning**

---

**Before opening the unit, disconnect the telephone-network cables to avoid contact with telephone-network voltages.** Statement 1041

---

**Warning**

---

**During this procedure, wear grounding wrist straps to avoid ESD damage to the card. Do not directly touch the backplane with your hand or any metal tool, or you could shock yourself.** Statement 93

---

**Warning**

---

**Invisible laser radiation may be emitted from disconnected fibers or connectors. Do not stare into beams or view directly with optical instruments.** Statement 1051

---

**Warning**

---

**During this procedure, wear grounding wrist straps to avoid ESD damage to the card. Do not directly touch the backplane with your hand or any metal tool, or you could shock yourself.** Statement 94

---

## Required Tools

These tools are required to install a supervisor engine in the chassis:

- Small flat-blade screwdriver
- No. 2 Phillips screwdriver
- Antistatic mat to support an unpackaged supervisor engine
- Your own ESD-prevention equipment or the disposable grounding wrist strap included with the module

## Installing a Supervisor Engine

This section describes how to safely install a supervisor engine.

**Caution**

---

To prevent ESD damage, handle the supervisor engine by the carrier edges only.

---

To install a supervisor engine in the chassis, follow these steps:

**Step 1**

Attach an ESD grounding strap to your wrist and to the ESD ground connector on the chassis or to a properly grounded bare metal surface.

**Note**

---

If you are unsure about the correct way to attach an ESD grounding strap, see the [“Attaching Your ESD Grounding Strap”](#) section on page C-1 for instructions.

---

**Step 2**

Determine the correct slot for the supervisor engine. The supervisor engines must be installed in these slots:

- Supervisor Engine 2
  - Slots 1 and 2 for all chassis
- Supervisor Engine 32
  - Slots 1 and 2 for 3- and 4-slot chassis

- Slots 5 and 6 for 6- and 9-slot chassis
  - Slots 7 and 8 for 13-slot chassis
- Supervisor Engine 32 PISA
  - Slots 1 and 2 for 3- and 4-slot chassis
  - Slots 5 and 6 for 6- and 9-slot chassis
  - Slots 7 and 8 for 13-slot chassis
- Supervisor Engine 720
  - Slots 1 and 2 for 3- and 4-slot chassis
  - Slots 5 and 6 for 6- and 9-slot chassis
  - Slots 7 and 8 for 13-slot chassis
- Supervisor Engine 720-10GE
  - Slots 1 and 2 for 3- and 4- slot chassis
  - Slots 5 and 6 for 6- and 9-slot chassis
  - Slots 7 and 8 for 13-slot chassis
- Supervisor Engine 2T
  - Slots 1 and 2 for 3- and 4- slot chassis
  - Slots 5 and 6 for 6- and 9-slot chassis
  - Slots 7 and 8 for 13-slot chassis

**Note**

If you are installing a Supervisor Engine 2T in your chassis, the slots directly adjacent (above and below in horizontal chassis or to the left and to the right in vertical chassis) to the supervisor engine must contain either a redundant Supervisor Engine 2T, line cards or switching-module filler plates (Cisco part numbers WS-X6K-SLOT-CVR-E or SLOTBLANK-09). If either slot is going to remain unused and currently has a blank slot cover (Cisco part number WS-X6K-SLOT-CVR) installed, you must remove the blank slot cover and replace it with a switching-module filler plate for NEBS compliance.

**Note**

The primary supervisor engine in a redundant supervisor engine configuration, or a single supervisor engine configuration can be installed in either of the two slots.

- Step 3** Visually verify that there is enough clearance to accommodate any interface equipment, such as pluggable transceivers, that you will install directly to the supervisor engine uplink ports.
- Step 4** If you are installing a Supervisor Engine 2T, verify that the two slots adjacent to the slot you are going to install the supervisor engine contain either another Supervisor Engine 2T, a module, or, if the slot is unused, a switching-module filler plate (Cisco part numbers WS-X6K-SLOT-CVR-E or SLOTBLANK-09).
- Step 5** Verify that the captive installation screws are tightened on all modules installed in the chassis.



---

**Note** This action assures that the EMI gaskets on all of the modules are fully compressed in order to maximize the opening space for the new or replacement supervisor engine. If the captive installation screws are loose, the EMI gaskets on the installed modules expand pushing adjacent modules toward the empty slot, reducing the opening size and making it difficult to install the supervisor engine.

---

**Step 6** If necessary, remove the blank slot cover or the switching-module filler plate covering the selected slot by removing the two Phillips pan-head screws. Set them aside for future use.



---

**Note** If you must remove an existing supervisor engine, refer to [“Removing a Supervisor Engine” section on page 3-10](#).

---

**Step 7** Remove the new supervisor engine from its shipping packaging and from the antistatic shipping bag.



---

**Caution** To prevent ESD damage, handle supervisor engines by the carrier edges or the bottom only. Do not touch the circuitry.

---

**Step 8** Fully open both ejector levers on the new supervisor engine. (See [Figure 3-1](#).)



**Step 9** Depending on the orientation of the slots in the chassis (horizontal or vertical), perform one of the following two sets of steps:

**Chassis with horizontal slots**

- a. Position the new supervisor engine in the slot. Make sure that you align the sides of the supervisor engine carrier with the slot guides on each side of the chassis slot. (See [Figure 3-1.](#))
- b. Carefully slide the supervisor engine into the slot until the EMI gasket along the top edge of the supervisor engine makes contact with the module or cover plate in the slot above it and the supervisor engine ejector levers have both closed to approximately 45 degrees with respect to the supervisor engine faceplate.

**Figure 3-1** Positioning the Supervisor Engine in a Horizontal Slot Chassis

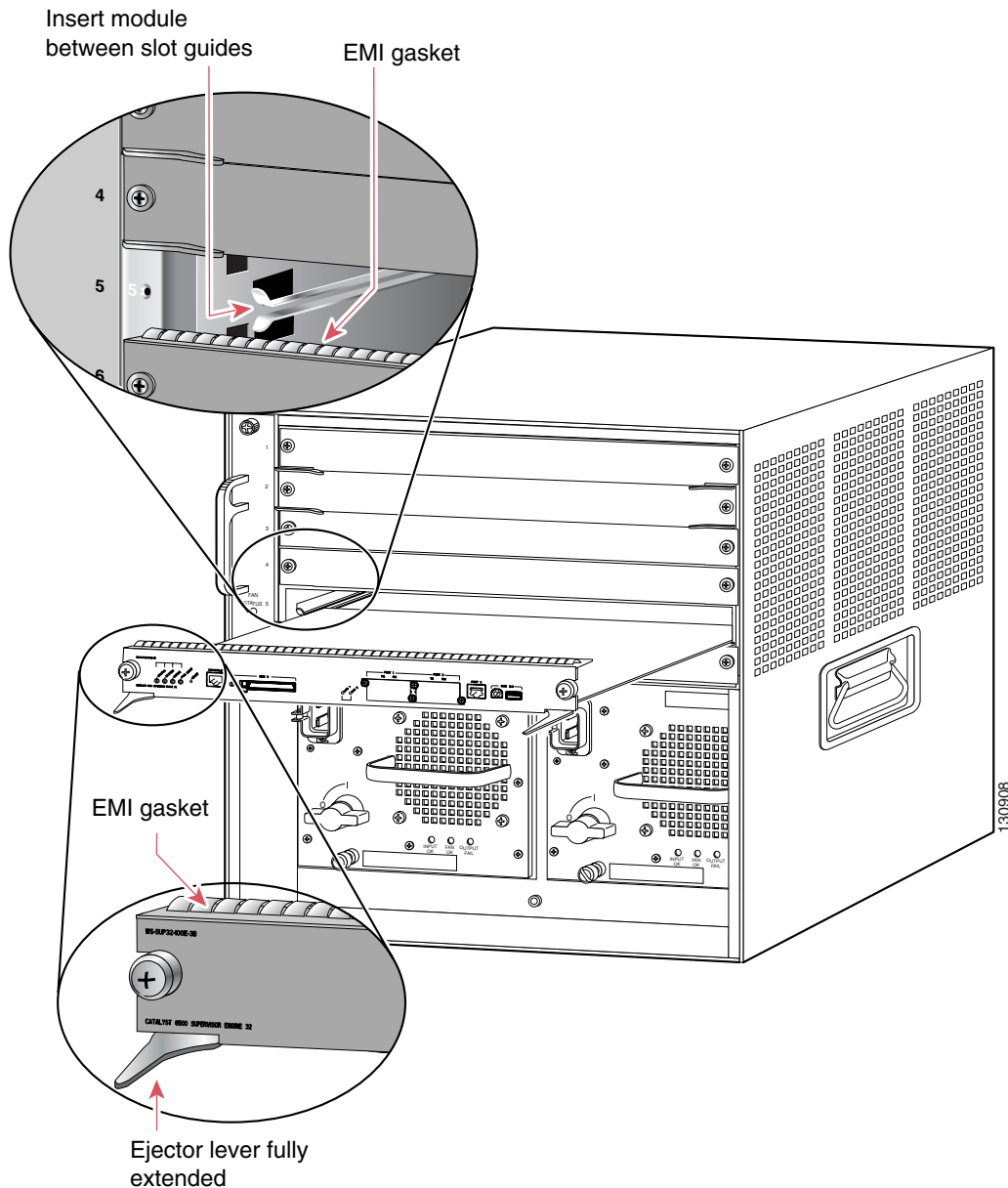

- c. Using the thumb and forefinger of each hand, grasp the two ejector levers and gently press down to create a small 0.040 inch (1 mm) gap between the supervisor engine's EMI gasket and the module or cover plate above it. (See [Figure 3-2](#).)



**Note** Do not press down too forcefully on the levers because they will bend and get damaged.

**Figure 3-2** Clearing the EMI Gasket in a Horizontal Slot Chassis

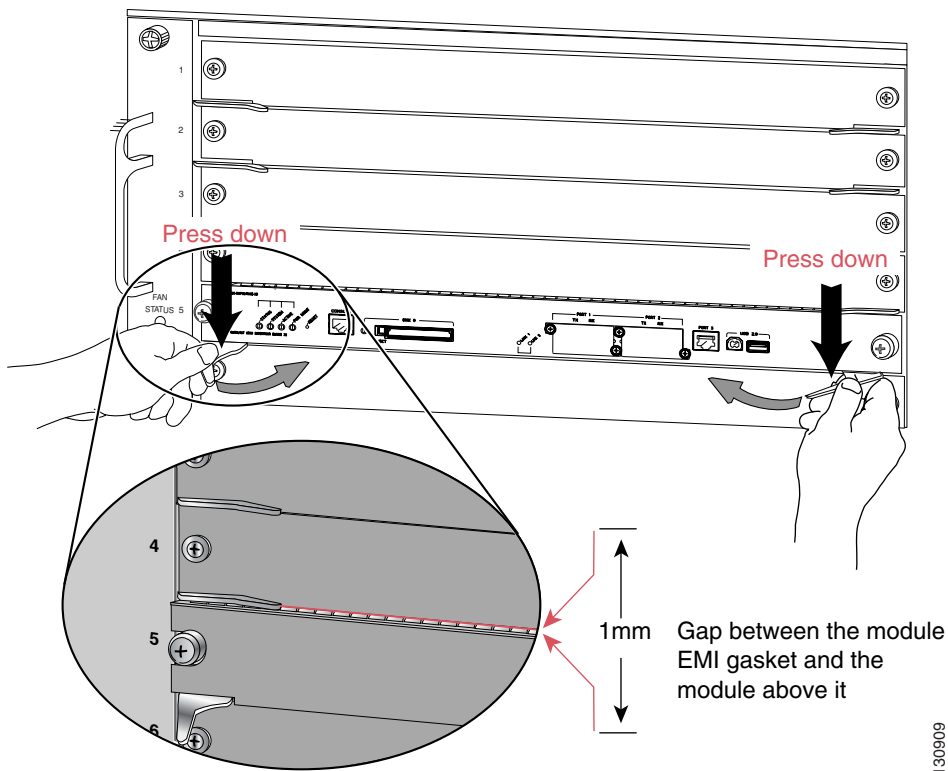

- d. While gently pressing down, simultaneously close the left and right ejector levers to fully seat the supervisor engine in the backplane connector. The ejector levers are fully closed when they are flush with the supervisor engine faceplate.



**Note** Failure to fully seat the supervisor engine in the backplane connector can result in error messages.

- e. Tighten the two captive installation screws on the supervisor engine.



**Note** Make sure the ejector levers are fully closed before tightening the captive installation screws.

- f. Verify that the supervisor engine STATUS LED is lit.

- g. Periodically check the STATUS LED.
- If the STATUS LED changes from orange to green, the supervisor engine has successfully completed the boot process and is now online.
  - If the STATUS LED remains orange or turns red, the supervisor engine has not successfully completed the boot process and may have encountered an error.

#### Chassis with vertical slots

- a. Position the supervisor engine in the slot. (See [Figure 3-3](#).) Make sure that you align the sides of the supervisor engine carrier with the slot guides on the top and bottom of the chassis slot.
- b. Carefully slide the supervisor engine into the slot until the EMI gasket along the right edge of the module makes contact with the module or cover plate in the slot adjacent to it and the module ejector levers have both closed to approximately 45 degrees with respect to the module faceplate. (See [Figure 3-4](#).)

**Figure 3-3** Positioning the Module in a Vertical Slot Chassis

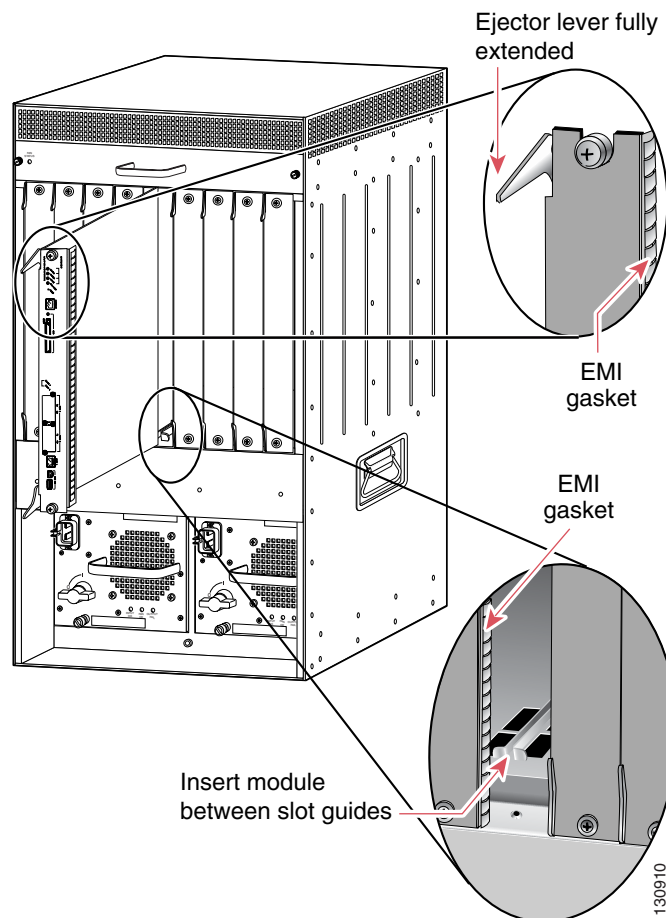
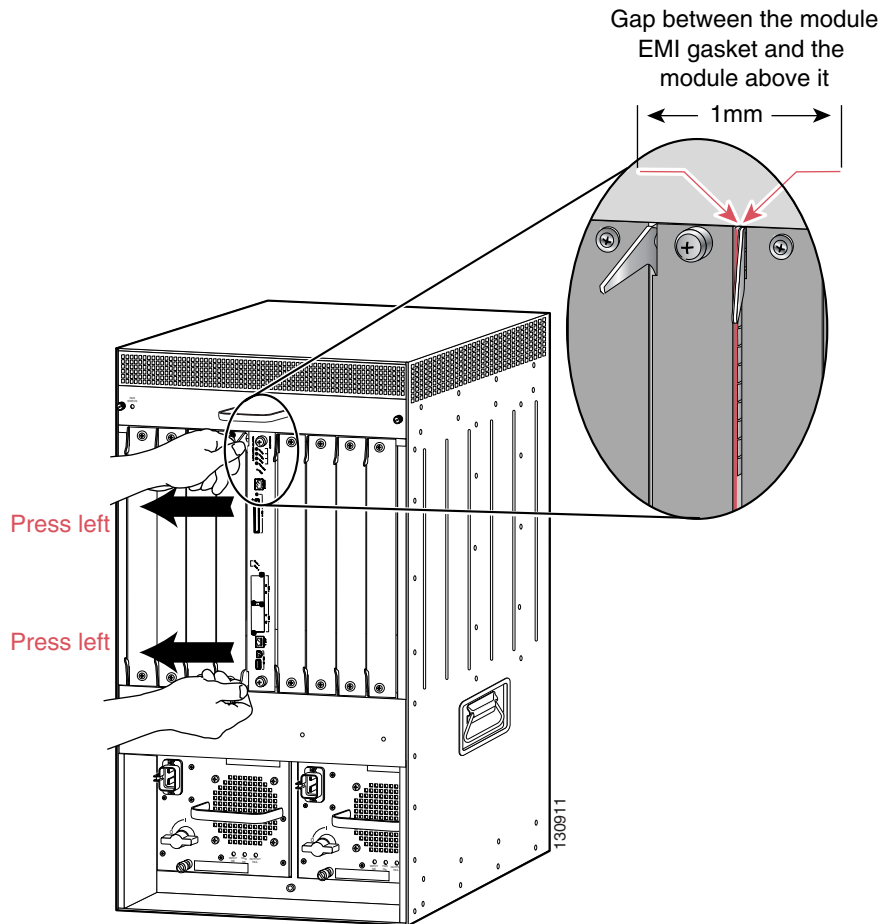

Figure 3-4 Clearing the EMI Gasket in a Vertical Slot Chassis



- c. Using the thumb and forefinger of each hand, grasp the two ejector levers and exert a slight pressure to the left, deflecting the supervisor engine approximately 0.040 inches (1 mm) creating a small gap between the supervisor engine's EMI gasket and the module or cover plate adjacent to it. (See [Figure 3-4](#).)



**Note** Do not exert too much pressure on the ejector levers because they will bend and get damaged.

- d. While gently pressing to the left on the ejector levers, simultaneously close both levers to fully seat the supervisor engine in the backplane connector. The ejector levers are fully closed when they are flush with the supervisor engine faceplate.
- e. Tighten the two captive installation screws on the supervisor engine.



**Note** Make sure that the ejector levers are fully closed before tightening the captive installation screws.

- f. Verify that the supervisor engine STATUS LED is lit.
- g. Periodically check the STATUS LED:

- If the STATUS LED changes from orange to green, the supervisor engine has successfully completed the boot process and is now online.
  - If the STATUS LED remains orange or turns red, the supervisor engine has not successfully completed the boot process and may have encountered an error.
-

# Removing a Supervisor Engine

This section describes how to remove a supervisor engine from the Catalyst 6500 series switch chassis.



## Caution

During this procedure, wear grounding wrist straps to avoid ESD damage to the module.



## Warning

**Invisible laser radiation may be emitted from disconnected fibers or connectors. Do not stare into beams or view directly with optical instruments.** Statement 1051

Before you remove a supervisor engine, you should first upload the current configuration to a server. This step saves time when bringing the module back online. You can recover the configuration by downloading it from the server to the nonvolatile memory of the supervisor engine. For more information, refer to Chapter 27, “Working with Configuration Files,” in the *Catalyst 6500 Series Switch Software Configuration Guide* or in Chapter 4, Chapter 5, and Chapter 6 in the *Catalyst 6500 Series Cisco IOS Software Configuration Guide*.

To remove a module from the chassis, follow these steps:

- Step 1** Attach an ESD grounding strap to your wrist and to the ESD ground connector on the chassis or to a properly grounded bare metal surface.



**Note** If you are unsure about the correct way to attach an ESD grounding strap, see the “[Attaching Your ESD Grounding Strap](#)” section on page C-1 for instructions.

- Step 2** Disconnect any network interface cables attached to the module.

- Step 3** Verify that the captive installation screws on all of the modules in the chassis are tight.



**Note** This step ensures that the space created by the removed module is maintained. If the captive installation screws are loose, the EMI gaskets on the installed modules will push the modules toward the open slot, reducing the opening size and making it difficult to remove the module.

- Step 4** Loosen the two captive screws on the module. Make sure that the two captive screws are completely unscrewed from the chassis.

- Step 5** Depending on the orientation of the slots in the chassis (horizontal or vertical), perform one of the following two sets of steps:

### Horizontal slots

- a. Place your thumbs on the left and right ejector levers and simultaneously rotate the levers outward to unseat the module from the backplane connector. (See [Figure 3-5](#).)
- b. Grasp the front edge of the module and slide the module part of the way out of the slot. Place your other hand under the module to support the weight of the module. Do not touch the module circuitry. (See [Figure 3-6](#).)

**Vertical slots**

- a. Place your thumbs on the ejector levers located at the top and bottom of the module, and simultaneously rotate the levers outward to unseat the module from the backplane connector.
- b. Grasp the edges of the module, and slide the module straight out of the slot. Do not touch the module circuitry.

**Figure 3-5** Opening the Ejector Levers (Horizontal Slot Chassis Shown)

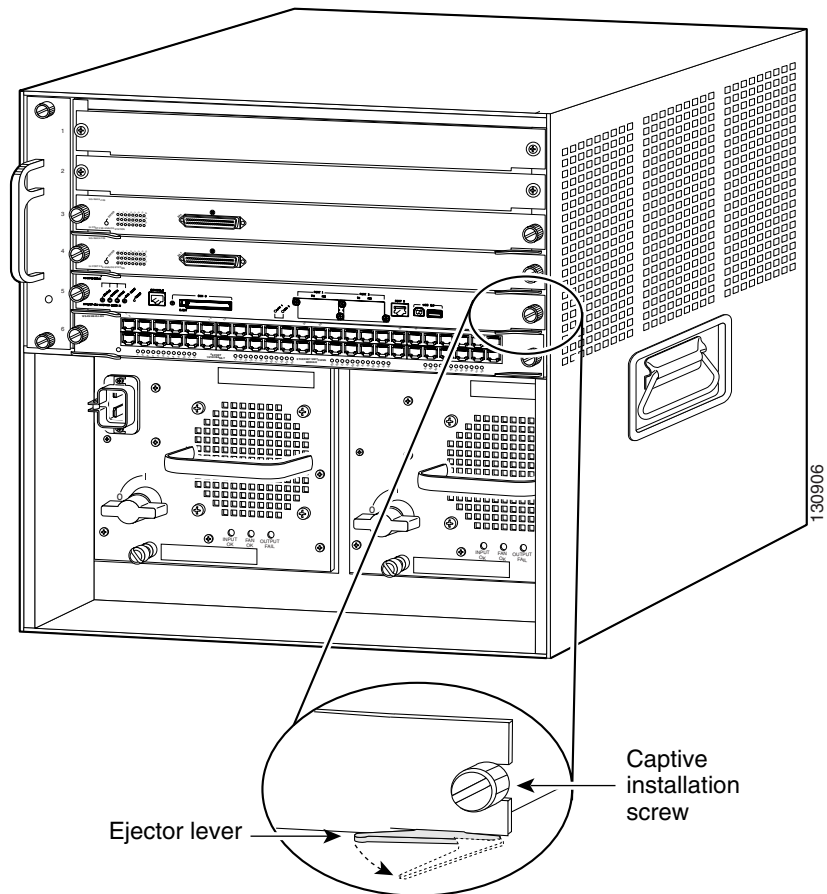

**Figure 3-6 Removing the Supervisor Engine (Horizontal Slot Chassis Shown)**

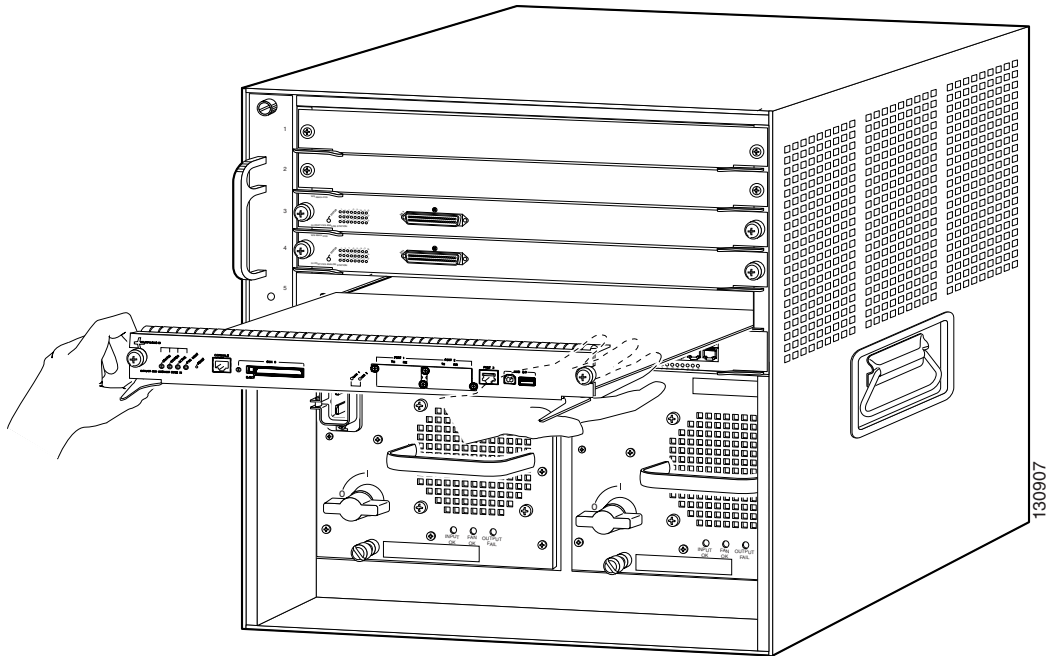

- Step 6** Place the removed module on an antistatic mat or in an antistatic bag, or immediately reinstall it in another slot.
- Step 7** If the slot is to remain empty, install a module filler plate to keep dust out of the chassis and to maintain proper airflow through the chassis. If a Supervisor Engine 2T or a WS-X6908-10G module is installed, the slots adjacent to either the supervisor engine or the module must have switching-module filler plates installed (Cisco part numbers WS-X6K-SLOT-CVR-E or SLOTBLANK-09). Do not install blank slot covers (WS-X6K-SLOT-CVR).



**Warning**

**Blank faceplates and cover panels serve three important functions: they prevent exposure to hazardous voltages and currents inside the chassis; they contain electromagnetic interference (EMI) that might disrupt other equipment; and they direct the flow of cooling air through the chassis. Do not operate the system unless all cards, faceplates, front covers, and rear covers are in place.** Statement 1029



**Warning**

**Invisible laser radiation may be emitted from disconnected fibers or connectors. Do not stare into beams or view directly with optical instruments.** Statement 1051



# USB Console Port Driver Installation

The USB port is on the front panel of the supervisor engine. To utilize the supervisor engine USB port, follow these steps:

- 
- Step 1** If you are connecting the switch USB console port to a Windows-based PC for the first time, install the USB driver.
- “Installing the Cisco Microsoft Windows XP USB Driver” section on page 3-14
  - “Installing the Cisco Microsoft Windows 2000 USB Driver” section on page 3-14
  - “Installing the Cisco Microsoft Windows Vista and Windows 7 USB Driver” section on page 3-15
- Step 2** Connect a USB cable to the PC USB port. Connect the other end of the cable to the switch mini-B (5-pin-connector) USB console port.
- Step 3** Start the terminal-emulation program on the PC or the terminal. The program, frequently a PC application such as HyperTerminal or ProcommPlus, makes communication between the switch and your PC or terminal possible.
- Step 4** Configure the baud rate and character format of the PC or terminal to match the console port default characteristics:
- 9600 baud
  - 8 data bits
  - 1 stop bit
  - No parity
  - None (flow control)
- Step 5** The PC or terminal displays the bootloader sequence. Press **Enter** to display the setup prompt. For configuration information, refer to the software configuration guide at the following URL:
- [http://www.cisco.com/en/US/docs/switches/lan/catalyst6500/ios/12.2SY/configuration/guide/sy\\_swcg.html](http://www.cisco.com/en/US/docs/switches/lan/catalyst6500/ios/12.2SY/configuration/guide/sy_swcg.html)
- 

## Installing the Cisco Microsoft Windows USB Device Driver

A USB device driver must be installed the first time a Microsoft Windows-based PC is connected to the USB console port on the switch.

- [Installing the Cisco Microsoft Windows XP USB Driver](#)
- [Installing the Cisco Microsoft Windows 2000 USB Driver](#)
- [Installing the Cisco Microsoft Windows Vista and Windows 7 USB Driver](#)

## Installing the Cisco Microsoft Windows XP USB Driver

To install the Cisco Microsoft Windows XP USB driver, follow these steps:

---

**Step 1** Obtain the Cisco USB console driver file from the Cisco.com web site and unzip it.



---

**Note** You can download the driver file from the Cisco.com site for downloading the switch software.

---

**Step 2** If using 32-bit Windows XP, double-click the setup.exe file in the Windows\_32 folder. If using 64-bit Windows XP, double-click the setup(x64).exe file in the Windows\_64 folder.

**Step 3** The Cisco Virtual Com InstallShield Wizard begins.

**Step 4** The Ready to Install the Program window appears. Click **Install**.

**Step 5** The InstallShield Wizard Completed window appears. Click **Finish**.

**Step 6** Connect the USB cable to the PC and the switch console port. The USB console port LED turns green, and the Found New Hardware Wizard appears. Follow the instructions to complete the driver installation.

---

## Installing the Cisco Microsoft Windows 2000 USB Driver

To install the Cisco Microsoft Windows 2000 USB driver, follow these steps:

---

**Step 1** Obtain the Cisco USB console driver file from the Cisco.com web site and unzip it.



---

**Note** You can download the driver file from the Cisco.com site for downloading the switch software.

---

**Step 2** Double-click the setup.exe file.

**Step 3** The Cisco Virtual Com InstallShield Wizard begins. Click **Next**.

**Step 4** The Ready to Install the Program window appears. Click **Install**.

**Step 5** The InstallShield Wizard Completed window appears. Click **Finish**.

**Step 6** Connect the USB cable to the PC and the switch console port. The USB console port LED turns green, and the Found New Hardware Wizard appears. Follow the instructions to complete the driver installation.

---

## Installing the Cisco Microsoft Windows Vista and Windows 7 USB Driver

To install the Cisco Microsoft Windows Vista and Windows 7 USB driver, follow these steps:

**Step 1** Obtain the Cisco USB console driver file from the Cisco.com web site and unzip it.



**Note** You can download the driver file from the Cisco.com site for downloading the switch software.

**Step 2** If using 32-bit Windows Vista or Windows 7, double-click the setup.exe file in the Windows\_32 folder. If using 64-bit Windows Vista or Windows 7, double-click the setup(x64).exe file in the Windows\_64 folder.

**Step 3** The Cisco Virtual Com InstallShield Wizard begins. Click **Next**.

**Step 4** The Ready to Install the Program window appears, Click **Install**.



**Note** If a User Account Control warning appears, click *Allow - I trust this program* to proceed.

**Step 5** The InstallShield Wizard Completed window appears. Click **Finish**.

**Step 6** Connect the USB cable to the PC and the switch console port. The USB console port LED turns green, and the Found New Hardware Wizard appears. Follow the instructions to complete the driver installation.

## Uninstalling the Cisco Microsoft Windows USB Driver

To uninstall the USB driver, select the procedure appropriate for your version of Microsoft Windows.

- [Uninstalling the Cisco Microsoft Windows XP and 2000 USB Driver](#)
- [Uninstalling the Cisco Microsoft Windows Vista and Windows 7 USB Driver](#)

### Uninstalling the Cisco Microsoft Windows XP and 2000 USB Driver

Use the Windows Add or Remove Programs utility or the setup.exe file to uninstall the Cisco Microsoft Windows XP and 2000 USB Driver.

#### Using the Add or Remove Programs utility



**Note** Disconnect the switch console terminal before uninstalling the driver.

**Step 1** Click **Start > Control Panel > Add or Remove Programs**.

**Step 2** Scroll to Cisco Virtual Com and click **Remove**.

**Step 3** When the Program Maintenance window appears, select the **Remove** radio button. Click **Next**.

## Using the Setup.exe program



---

**Note** Disconnect the switch console terminal before uninstalling the driver.

---

- Step 1** Run setup.exe for Windows 32-bit or setup(x64).exe for Windows-64bit. Click **Next**.
- Step 2** The InstallShield Wizard for Cisco Virtual Com appears. Click **Next**.
- Step 3** When the Program Maintenance window appears, select the **Remove** radio button. Click **Next**.
- Step 4** When the Remove the Program window appears, click **Remove**.
- Step 5** When the InstallShield Wizard Completed window appears click **Finish**.
- 

## Uninstalling the Cisco Microsoft Windows Vista and Windows 7 USB Driver

To uninstall the Cisco Microsoft Vista or Windows 7 USB driver, follow these steps:



---

**Note** Disconnect the switch console terminal before uninstalling the driver.

---

- Step 1** Run setup.exe for Windows 32-bit or setup(x64).exe for Windows-64bit. Click **Next**.
- Step 2** The InstallShield Wizard for Cisco Virtual Com appears. Click **Next**.
- Step 3** When the Program Maintenance window appears, select the **Remove** radio button. Click **Next**.
- Step 4** When the Remove the Program window appears, click **Remove**.



---

**Note** If a User Account Control warning appears, click *Allow - I trust this program* to proceed.

---

- Step 5** When the InstallShield Wizard Completed window appears click **Finish**.
-

# Installing Pluggable Transceivers

Supervisor engine uplink ports require that pluggable transceivers be installed in the uplink port sockets. These transceivers are normally shipped separately from the supervisor engine and must be installed after the supervisor engine is installed in the chassis. Table 3-1 lists the types of transceivers used in the supervisor engine uplink ports and the location on cisco.com of the specific installation instructions for the transceiver.

**Table 3-1 Supervisor Engine Uplink Port Transceiver Installation Procedures**

Transceiver Type	Transceiver Installation Procedure
GBIC	<a href="http://www.cisco.com/en/US/docs/interfaces_modules/transceiver_modules/installation/note/78_15299.html">http://www.cisco.com/en/US/docs/interfaces_modules/transceiver_modules/installation/note/78_15299.html</a>
SFP	<a href="http://www.cisco.com/en/US/docs/interfaces_modules/transceiver_modules/installation/note/78_15160.html">http://www.cisco.com/en/US/docs/interfaces_modules/transceiver_modules/installation/note/78_15160.html</a>
XENPAK	<a href="http://www.cisco.com/en/US/docs/interfaces_modules/transceiver_modules/installation/note/78_15665.html">http://www.cisco.com/en/US/docs/interfaces_modules/transceiver_modules/installation/note/78_15665.html</a>
X2	<a href="http://www.cisco.com/en/US/docs/interfaces_modules/transceiver_modules/installation/note/OL_23589.html">http://www.cisco.com/en/US/docs/interfaces_modules/transceiver_modules/installation/note/OL_23589.html</a>



### Caution

We strongly recommend that you do not install or remove any of the transceiver with a fiber-optic cable attached to it because of the potential damage to the cable, the cable connector, or the optical interfaces in the transceiver. Disconnect the network interface cable before removing or installing any transceiver.



### Warning

**Invisible laser radiation may be emitted from disconnected fibers or connectors. Do not stare into beams or view directly with optical instruments.** Statement 1051



### Note

For information on inspecting and cleaning fiber-optic interfaces, see the document at this URL:

[http://www.cisco.com/en/US/tech/tk482/tk876/technologies\\_white\\_paper09186a0080254eba.shtml](http://www.cisco.com/en/US/tech/tk482/tk876/technologies_white_paper09186a0080254eba.shtml)

## Attaching the Network Interface Cables

This section describes how to attach network interface cables (optical and copper) to the supervisor engine uplink ports and contains the following topics:

- [Attaching Optical Network Interface Cables](#), page 3-18
- [Mode-Conditioning Patch Cord](#), page 3-18
- [Connecting Transceivers to a Copper Network](#), page 3-22

## Attaching Optical Network Interface Cables

Before you remove the dust plugs from the connector optical bores and make any connections, observe the following guidelines:

- Always keep the protective dust plugs on the unplugged fiber-optic cable connectors and the transceiver optical bores until you are ready to make a connection.



### Caution

Do not remove the plugs from the transceiver optical bores or the fiber-optic cable until you are ready to connect the cable. The plugs protect the transceiver optical bores and cable from contamination.

- Always inspect and clean the SC or the LC connector end-faces just before making any connections. Refer to the Tip on inspecting and cleaning fiber-optic connections for the location of a document that describes the fiber-optic inspection and cleaning process.
- Always grasp the SC or the LC connector housing instead of the fiber-optic cable to plug or unplug the fiber-optic cable.

To install the optical interface cables, follow these steps:

**Step 1** Remove the dust plugs from the network interface cable optical connectors. Save the dust plugs for future use.

**Step 2** Immediately inspect and clean the optical connector's fiber-optic end faces.



### Tip

For complete information on inspecting and cleaning fiber-optic connections, see the document at this URL:

[http://www.cisco.com/en/US/tech/tk482/tk876/technologies\\_white\\_paper09186a0080254eba.shtml](http://www.cisco.com/en/US/tech/tk482/tk876/technologies_white_paper09186a0080254eba.shtml)

## Mode-Conditioning Patch Cord

A mode-conditioning patch cord is recommended for use with an LX/LH GBIC transceiver or an LX/LH SFP transceiver and multimode fiber (MMF) to allow reliable laser transmission. Table 3-2 lists the three types of mode-conditioning patch cords available from Cisco:

**Table 3-2** Mode-Conditioning Patch Cords

Mode-Conditioning Patch Cord	Description
CAB-GELX-625=	IEEE 802.3z-compliant optical fiber assembly consisting of a single-mode fiber permanently coupled off-center to a 62.5-micron multimode optical fiber with duplex SC male connectors at both ends. The patch cord is 3 meters (9.84 feet) in length.

**Table 3-2 Mode-Conditioning Patch Cords (continued)**

Mode-Conditioning Patch Cord	Description
CAB-MCP50-SC=	IEEE 802.3z-compliant optical fiber assembly consisting of a single-mode fiber permanently coupled off-center to a 50-micron multimode optical fiber with duplex SC male connectors at both ends. The patch cord is 1 meter (3.28 feet) in length.
CAB-MCP-LC=	IEEE 802.3z-compliant optical fiber assembly consisting of a single-mode fiber permanently coupled off-center to a 62.5-micron multimode optical fiber with duplex SC male connectors at one end and duplex LC male connectors at the other end. The patch cord is 1 meter (3.28 feet) in length.

Table 3-3 lists the optical transceivers that require a mode-conditioning patch cord.

**Table 3-3 Optical Transceivers Using a Mode-Conditioning Patch Cord**

Transceiver	Mode-Conditioning Patch Cord Usage
GBIC LX/LH (WS-G5486=)	When using an LX/LH GBIC with 62.5-micron diameter MMF, you must install a mode-conditioning patch cord (CAB-GELX-625 or equivalent) between the GBIC and the MMF cable on both the transmit and receive ends of the link. The mode-conditioning patch cord is required for: <ul style="list-style-type: none"> <li>Link distances less than 328 feet (100 m), where the mode-conditioning patch cord prevents overdriving the receiver.</li> <li>Link distances greater than 984 feet (300 m), where it reduces differential mode delay.</li> </ul>
SFP LX/LH (GLC-LH-SM=)	When using the LX/LH SFP transceiver with 62.5-micron diameter MMF, you must also install a mode-conditioning patch cord (CAB-GELX-625 or equivalent) between the SFP transceiver and the MMF cable on both the sending and receiving ends of the link. The mode-conditioning patch cord is required for: <ul style="list-style-type: none"> <li>Link distances less than 328 feet (100 m), where it prevents overdriving the receiver.</li> <li>Link distances greater than 984 feet (300 m), where it reduces differential mode delay.</li> </ul>
XENPAK LX4 (XENPAK-10GB-LX4=)	The Cisco XENPAK-10GB-LX4 transceiver supports link lengths of 984 feet (300 meters) on standard FDDI grade MMF. To ensure that specifications are met, the transmitter output should be coupled through a mode conditioning patch cord. Cisco offers two mode conditioning patch cords: CAB-GELX-625= (mode conditioning patch cable 62.5 microns, dual SC connectors) and CAB-MCP50-SC= (mode conditioning patch cable 50 microns, dual SC connectors).

**Table 3-3** *Optical Transceivers Using a Mode-Conditioning Patch Cord*

Transceiver	Mode-Conditioning Patch Cord Usage
XENPAK LRM (XENPAK-10GB-LRM=)	The Cisco XENPAK-10GB-LRM transceiver supports link lengths of 722 feet (220 m) on standard Fiber Distributed Data Interface (FDDI) grade multimode fiber (MMF). To ensure that specifications are met over FDDI-grade, OM1 and OM2 fibers, the transmitter should be coupled through a mode conditioning patch cord. Cisco offers two mode conditioning patch cords: CAB-GELX-625= (mode conditioning patch cable 62.5 microns, dual SC connectors) and CAB-MCP50-SC= (mode conditioning patch cable 50 microns, dual SC connectors). No mode conditioning patch cord is required for applications over OM3 fiber.
X2 LRM (X2-10GB-LRM)	The Cisco X2-10GB-LRM transceiver supports link lengths of 220 meters on standard Fiber Distributed Data Interface (FDDI) grade multimode fiber (MMF). To ensure that specifications are met over FDDI-grade, OM1 and OM2 fibers, the transmitter should be coupled through a mode conditioning patch cord. Cisco offers two mode conditioning patch cords: CAB-GELX-625= (mode conditioning patch cable 62.5 microns, dual SC connectors) and CAB-MCP50-SC= (mode conditioning patch cable 50 microns, dual SC connectors). No mode conditioning patch cord is required for applications over OM3.
X2 LX4 (X2-10GB-LX4)	The Cisco X2-10GB-LX4 transceiver supports link lengths of 300 meters on standard FDDI grade MMF. To ensure that specifications are met, the transmitter output should be coupled through a mode conditioning patch cord. Cisco offers two mode conditioning patch cords: CAB-GELX-625= (mode conditioning patch cable 62.5 microns, dual SC connectors) and CAB-MCP50-SC= (mode conditioning patch cable 50 microns, dual SC connectors).

When an unconditioned laser source designed for operation on single-mode optical fiber is directly coupled to a multimode optical fiber cable, an effect known as *differential mode delay* (DMD) might result in a degradation of the modal bandwidth of the optical fiber cable.

This degradation results in a decrease in the link span (the distance between a transmitter and a receiver) that can be supported reliably. The effect of DMD can be overcome by conditioning the launch characteristics of a laser source. A practical means of performing this conditioning is to use a device called a mode-conditioning patch cord.



A mode-conditioning patch cord is an optical fiber cable assembly that consists of a pair of optical fibers terminated with connector hardware. Specifically, the mode-conditioning patch cord is composed of a single-mode optical fiber permanently coupled off-center (see Offset in Figure 3-7 and Figure 3-8) to a graded-index multimode optical fiber. Figure 3-7 and Figure 3-8 show a diagram of the mode-conditioning patch cord assembly.

**Figure 3-7 Mode Conditioning Patch Cord with SC (GBIC Transceiver) Connector**

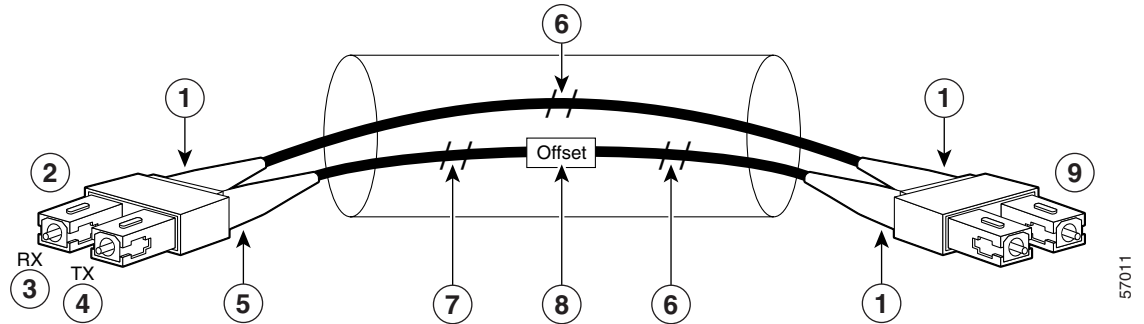

1	Beige color identifier	6	Multimode fiber (MMF)
2	To Gigabit Ethernet interface (SC male connector)	7	Single-mode fiber (SMF)
3	Rx (receiver)	8	Offset junction
4	Tx (transmitter)	9	To cable plant (SC male connector)
5	Blue color identifier		

**Figure 3-8 Mode Conditioning Patch Cord with LC (SFP Transceiver) Connector**

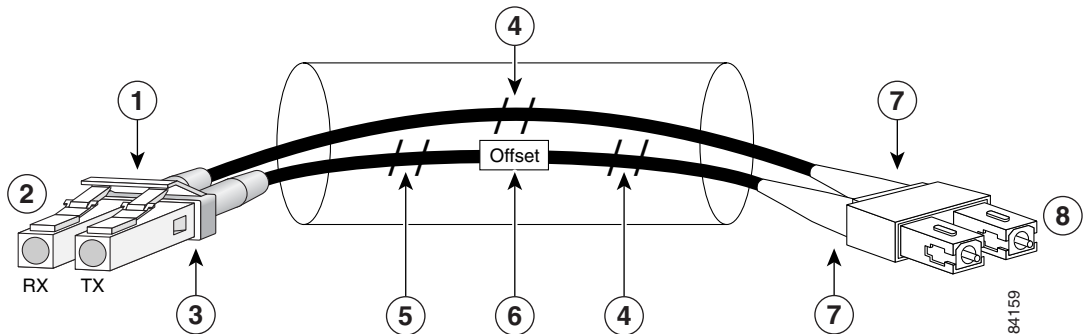

1	Gray color identifier	5	Single-mode fiber
2	To Gigabit Ethernet interface (LC male connector)	6	Offset junction
3	Blue color identifier	7	Beige color identifier
4	Multimode fiber	8	To cable plant (SC male connector)

The mode-conditioning patch cord assembly is composed of duplex optical fibers, including a single-mode-to-multimode offset launch fiber connected to the transmitter, and a second conventional graded-index multimode optical fiber connected to the receiver. The use of a plug-to-plug patch cord maximizes the power budget of multimode 1000BASE-LX/LH links.

**Note**

The mode-conditioning patch cord is required to comply with IEEE standards. The IEEE found that link distances could not be met with certain types of fiber-optic cable cores. The solution is to launch light from the laser at a precise offset from the center, which is accomplished by using the mode-conditioning patch cord. At the output end of the patch cord, the GBIC-LX/LH is compliant with the IEEE 802.3z standard for 1000BASE-LX.

## Connecting Transceivers to a Copper Network

**Caution**

To comply with GR-1089 intrabuilding lightning immunity requirements, you must use grounded, shielded, twisted-pair Category 5 cabling.

To connect transceivers to a copper network, follow these steps:

**Step 1** Insert the network cable RJ-45 connector into the RJ-45 connector on the transceiver.

**Note**

When connecting to a 1000BASE-T-compatible switch or repeater, use four-twisted-pair, crossover Category 5 cabling.

**Step 2** Insert the other end of the network cable into an RJ-45 connector on a 1000BASE-T-compatible target device.

## Where to Go Next

For complete information on verifying the installation of the supervisor engine configuration information, see the *Catalyst 6500 Series Switch Software Configuration Guide* or the *Catalyst 6500 Series Switch Cisco IOS Software Configuration Guide*. For information on all Catalyst 6500 series switch commands, see the *Catalyst 6500 Series Switch Command Reference* or the *Catalyst 6500 Series Switch Cisco IOS Command Reference* publications.



# APPENDIX **A**

## Pluggable Transceivers

---

Revised: July 2012

This appendix provides pointers and references for the pluggable optical and copper transceivers that are supported on the Catalyst 6500 series supervisor engine uplink ports.

[Table A-1](#) lists the supervisor engine models and the transceiver types and quantities that they support.

**Table A-1** Supervisor Engine Transceiver Support

Supervisor Engine	Number of Ports Supporting Transceivers	Transceiver Type Supported
Supervisor Engine 2 (all models)	2	GBIC
Supervisor Engine 32 (WS-SUP32-GE-3B and WS-S32-GE-PISA only)	8	SFP
Supervisor Engine 32 (WS-SUP32-10GE-3B and WS-S32-10GE-PISA only)	2	XENPAK
Supervisor Engine 720 (WS-SUP720, WS-SUP720-3B, and WS-SUP720-3BXL)	2	SFP
Supervisor Engine 720-10GE (VS-S720-10G-3C and VS-S720-10G-3CXL)	4	X2 or SFP+ (2 ports) <sup>1</sup> SFP (2 ports)
Supervisor Engine 2T (VS-S2T-10G and VS-S2T-10GXL)	5	X2 (2 ports) SFP (3 ports)

1. A OneX Converter Module (CVR-X2-SFP10G) is required to install an SFP+ transceiver in an X2 socket.

For up to date information on which models of a specific type of transceiver are supported on a supervisor engine, refer to the transceiver compatibility matrices at the following url:

[http://www.cisco.com/en/US/products/hw/modules/ps5455/products\\_device\\_support\\_tables\\_list.html](http://www.cisco.com/en/US/products/hw/modules/ps5455/products_device_support_tables_list.html)

For transceiver installation and removal instructions, refer to the individual transceiver installation notes at the following url:

[http://www.cisco.com/en/US/products/hw/modules/ps5455/prod\\_installation\\_guides\\_list.html](http://www.cisco.com/en/US/products/hw/modules/ps5455/prod_installation_guides_list.html)

To clean the optical connectors on transceivers and the fiber optic cable, use a CLETOP cassette cleaner and follow the product directions. If a CLETOP cassette cleaner is not available or if you want additional cleaning information, refer to the *Inspection and Cleaning Procedures for Fiber-Optic Connections* document at the following URL:

[http://www.cisco.com/en/US/tech/tk482/tk876/technologies\\_white\\_paper09186a0080254eba.shtml](http://www.cisco.com/en/US/tech/tk482/tk876/technologies_white_paper09186a0080254eba.shtml)



**Warning**

---

**Invisible laser radiation may be emitted from disconnected fibers or connectors. Do not stare into beams or view directly with optical instruments.** Statement 1051

---



# APPENDIX **B**

## Port, Cable, and Connector Specifications

---

**Revised: July 2011**

This appendix lists the port, cable, and connector specifications for the Catalyst 6500 series supervisor engines. The following ports, cables, and connectors along with signal summaries are contained in this appendix:

- [Console Port, page B-1](#)
- [Uplink Ports, page B-5](#)
- [USB Ports, page B-7](#)
- [Copper and Fiber-Optic Connectors, page B-7](#)

Also included in this appendix is information and procedures on how to clean the fiber-optic connectors.

### Console Port

The console port allows you to access the switch either locally (through a console terminal) or remotely (through a modem). The console port is an EIA/TIA-232 asynchronous, serial connection with hardware flow control and an RJ-45 connector. This section covers the following topics:

- [Console Port Cables and Adapters, page B-1](#)
- [CONSOLE PORT MODE Switch \(Supervisor Engine 2 Only\), page B-2](#)

### Console Port Cables and Adapters

The Catalyst 6500 series switch comes with an accessory kit that contains the cable and adapters you need to connect a console (an ASCII terminal or PC running terminal emulation software) or modem to the supervisor engine console port. The accessory kit includes the following items:

- RJ-45-to-RJ-45 rollover cable
- RJ-45-to-DB-9 female DTE adapter (labeled “Terminal”)
- RJ-45-to-DB-25 female DTE adapter (labeled “Terminal”)
- RJ-45-to-DB-25 male DCE adapter (labeled “Modem”)



**Note**

---

This is the same rollover cable and connector adapters that ship with many other Cisco products.

---

You can identify a rollover cable by comparing the two ends of the cable. Holding the cables side-by-side, with the tab at the back, the wire connected to the pin on the outside of the left plug should be the same color as the wire connected to the pin on the outside of the right plug. (See [Figure B-1](#).) If your cable was purchased from Cisco Systems, pin 1 will be white on one connector, and pin 8 will be white on the other (a rollover cable reverses pins 1 and 8, 2 and 7, 3 and 6, and 4 and 5).

**Figure B-1** Identifying a Rollover Cable

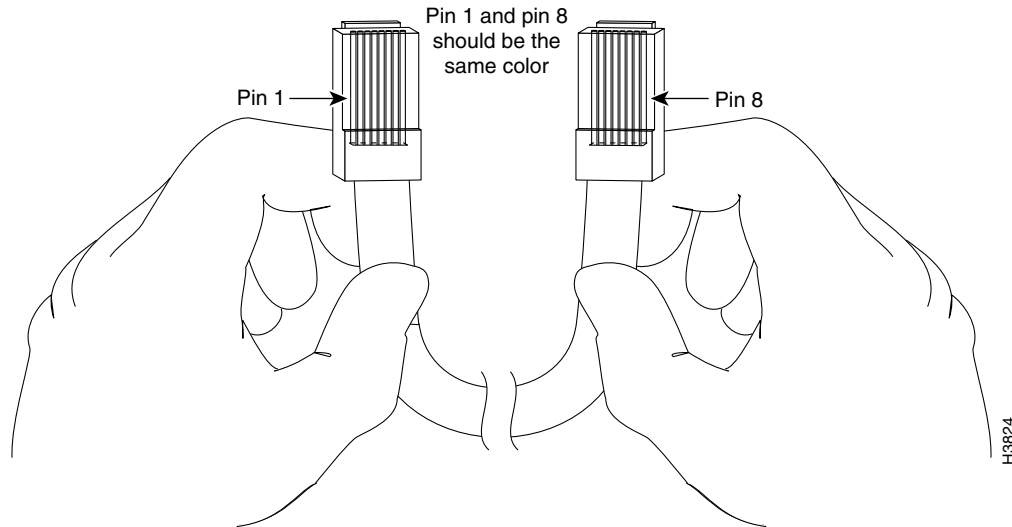

## CONSOLE PORT MODE Switch (Supervisor Engine 2 Only)

The supervisor engine front-panel CONSOLE PORT MODE switch, only on the Supervisor Engine 2, allows you to connect a terminal or modem to the console port as follows:

- Mode 1—Switch in the *in* position. Use this mode to connect a terminal to the console port using the RJ-45-to-RJ-45 rollover cable and DTE adapter (labeled “Terminal”).  
You can also use this mode to connect a modem to the console port using the RJ-45-to-RJ-45 rollover cable and DCE adapter (labeled “Modem”).
- Mode 2—Switch in the *out* position. Use this mode to connect a terminal to the console port using the Catalyst 5000 family Supervisor Engine III console cable and appropriate adapter for the terminal connection (cable and adapter are not provided).



**Note**

Use a ballpoint pen tip or other small, pointed object to access the CONSOLE PORT MODE switch. The switch is shipped in the *in* position.

## Console Port Mode 1 Signaling and Pinouts

This section provides the signaling and pinouts for the console port in mode 1 (CONSOLE PORT MODE switch in the *in* position).

### DB-9 Adapter (for Connecting to a PC)

Use the RJ-45-to-RJ-45 rollover cable and RJ-45-to-DB-9 female DTE adapter (labeled “Terminal”) to connect the console port to a PC running terminal emulation software. [Table B-1](#) lists the pinouts for the asynchronous serial console port, the RJ-45-to-RJ-45 rollover cable, and the RJ-45-to-DB-9 female DTE adapter.

**Table B-1** Port Mode 1: Console Port Signaling and Pinouts (DB-9 Adapter)

Console Port	RJ-45-to-RJ-45 Rollover Cable		RJ-45-to-DB-9 Terminal Adapter	Console Device
	RJ-45 Pin	RJ-45 Pin	DB-9 Pin	Signal
RTS	1 <sup>1</sup>	8	8	CTS
DTR	2	7	6	DSR
TxD	3	6	2	RxD
GND	4	5	5	GND
GND	5	4	5	GND
RxD	6	3	3	TxD
DSR	7	2	4	DTR
CTS	8 <sup>1</sup>	1	7	RTS

1. Pin 1 is connected internally to Pin 8.

## DB-25 Adapter (for Connecting to a Terminal)

Use the RJ-45-to-RJ-45 rollover cable and the RJ-45-to-DB-25 female DTE adapter (labeled “Terminal”) to connect the console port to a terminal. [Table B-2](#) lists the pinouts for the asynchronous serial console port, the RJ-45-to-RJ-45 rollover cable, and the RJ-45-to-DB-25 female DTE adapter.

**Table B-2** *Port Mode 1: Console Port Signaling and Pinouts (DB-25 Adapter)*

Console Port	RJ-45-to-RJ-45 Rollover Cable		RJ-45-to-DB-25 Terminal Adapter	Console Device	
	Signal	RJ-45 Pin	RJ-45 Pin		DB-25 Pin
RTS	1 <sup>1</sup>	8	5	5	CTS
DTR	2	7	6	6	DSR
TxD	3	6	3	3	RxD
GND	4	5	7	7	GND
GND	5	4	7	7	GND
RxD	6	3	2	2	TxD
DSR	7	3	20	20	DTR
CTS	8 <sup>1</sup>	1	4	4	RTS

1. Pin 1 is connected internally to Pin 8.

## Modem Adapter

Use the RJ-45-to-RJ-45 rollover cable and the RJ-45-to-DB-25 male DCE adapter (labeled “Modem”) to connect the console port to a modem. [Table B-3](#) lists the pinouts for the asynchronous serial auxiliary port, the RJ-45-to-RJ-45 rollover cable, and the RJ-45-to-DB-25 male DCE adapter.

**Table B-3** *Port Mode 1: Console Port Signaling and Pinouts (Modem Adapter)*

Console Port	RJ-45-to-RJ-45 Rollover Cable		RJ-45-to-DB-25 Modem Adapter	Modem	
	Signal	RJ-45 Pin	RJ-45 Pin		DB-25 Pin
RTS	1 <sup>1</sup>	8	4	4	RTS
DTR	2	7	20	20	DTR
TxD	3	6	3	3	TxD
GND	4	5	7	7	GND
GND	5	4	7	7	GND
RxD	6	3	2	2	RxD
DSR	7	3	8	8	DCD
CTS	8 <sup>1</sup>	1	5	5	CTS

1. Pin 1 is connected internally to Pin 8.



## Console Port Mode 2 Signaling and Pinouts

This section provides the signaling and pinouts for the console port in mode 2 (CONSOLE PORT MODE switch in the *out* position). See [Table B-4](#) for the pinouts.

**Table B-4** Console Port Pinouts (Port Mode Switch Out)

Console Port	Console Device
Pin (signal)	Input/Output
1 (RTS) <sup>1</sup>	Output
2 (DTR)	Output
3 (RxD)	Input
4 (GND)	GND
5 (GND)	GND
6 (TxD)	Output
7 (DSR)	Input
8 (CTS) <sup>1</sup>	Input

1. Pin 1 is connected internally to Pin 8.

## Uplink Ports

The Supervisor Engine 2, Supervisor Engine 32, Supervisor Engine 32 PISA, the Supervisor Engine 720, Supervisor Engine 720-10GE, and the Supervisor Engine 2T all have Ethernet uplink ports available on the front panel. These Ethernet ports can be used to provide additional port capacity for a fully configured switch or can reduce the need to use a chassis slot for a Gigabit Ethernet module or 10-Gigabit Ethernet module where only a few Gigabit or 10-Gigabit Ethernet ports are required. [Table B-5](#) lists the supervisor engine model and the number and type of uplink ports available.

**Table B-5** Supervisor Engine Uplink Ports

Supervisor Engine	Number of Uplink Ports	Type of Uplink Port
Supervisor Engine 2	2	Two 1000BASE-X ports (The two ports require GBIC transceivers.)
Supervisor Engine 32 (WS-SUP32-GE-3B and WS-SUP32P-GE)	9	<ul style="list-style-type: none"> <li>Eight 1000BASE-X ports (The eight ports require SFP transceivers.)</li> <li>One 10/100/1000 RJ-45 port (The port does not require a pluggable transceiver.)</li> </ul>
Supervisor Engine 32 (WS-SUP32-10GE-3B and WS-SUP32P-10GE)	3	<ul style="list-style-type: none"> <li>Two 10-GBASE-X (The two ports require XENPAK transceivers)</li> <li>One 10/100/1000 RJ-45 port (The port does not require a pluggable transceiver)</li> </ul>

**Table B-5** Supervisor Engine Uplink Ports (continued)

Supervisor Engine	Number of Uplink Ports	Type of Uplink Port
Supervisor Engine 720	3	<ul style="list-style-type: none"> <li>Two 1000BASE-X ports (The two ports require SFP transceivers)</li> <li>One 10/100/1000 RJ-45 port (The port does not require a pluggable transceiver)</li> </ul> <p><b>Note</b> Only two uplink ports can be used at one time.</p>
Supervisor Engine 720-10GE	5	<ul style="list-style-type: none"> <li>Two 10-GBASE-X ports (The ports require X2 transceivers)</li> <li>Two 1000BASE-X ports (The ports require SFP transceivers)</li> <li>One 10/100/1000 RJ-45 port (The port does not require a pluggable transceiver)</li> </ul>
Supervisor Engine 2T	5	<ul style="list-style-type: none"> <li>Three 1000BASE-X ports (The ports require SFP transceivers)</li> <li>Two 10-GBASE-X ports (The ports require X2 transceivers)</li> </ul>

Three types of XENPAK and X2 transceivers have cabling guidelines. The transceivers types and their guidelines are listed in [Table B-6](#).

**Table B-6** Cabling Guidelines for Transceivers

Transceiver Type	Cabling Guideline
LX4 (XENPAK-10GB-LX4 and X2-10GB-LX4)	<p>The Cisco LX4 transceiver supports link lengths of 300 meters on standard FDDI grade MMF. To ensure that specifications are met, the transmitter output should be coupled through a mode conditioning patch cord. Cisco offers two mode conditioning patch cords:</p> <ul style="list-style-type: none"> <li>CAB-GELX-625=—Mode-conditioning patch cable supporting 62.5 micron fiber with dual SC connectors.</li> <li>CAB-MCP50-SC=—Mode-conditioning patch cable supporting 50 micron fiber with dual SC connectors.</li> </ul>

**Table B-6** *Cabling Guidelines for Transceivers (continued)*

Transceiver Type	Cabling Guideline
CX4 (XENPAK10GB-CX4 and X2-10GB-CX4)	The Cisco CX4 transceiver supports link lengths of up to 49.2 feet (15 m) on CX4 cable. Cisco offers four CX4 cables: <ul style="list-style-type: none"> <li>• CAB-INF-28G-1= (1 meter cable)</li> <li>• CAB-INF-28G-5= (5 meter cable)</li> <li>• CAB-INF-28G-10= (10 meter cable)</li> <li>• CAB-INF-28G-15= (15 meter cable)</li> </ul>
LRM (XENPAK-10GB-LRM and X2-10GB-LRM)	The Cisco LRM transceiver supports link lengths of 220 meters on standard Fiber Distributed Data Interface (FDDI) grade multimode fiber (MMF). To ensure that specifications are met over FDDI-grade, OM1 and OM2 fibers, the transmitter should be coupled through a mode-conditioning patch cord. Cisco offers two mode-conditioning patch cords: <ul style="list-style-type: none"> <li>• CAB-GELX-625= —Mode-conditioning patch cable (62.5 microns) with dual SC connectors.</li> <li>• CAB-MCP50-SC= —Mode-conditioning patch cable (50 microns) with dual SC connectors. No mode-conditioning patch cord is required for applications over OM3 fiber cable.</li> </ul>

## USB Ports

Supervisor Engine 32, Supervisor Engine 32 PISA, Supervisor Engine 720-10GE, and Supervisor Engine 2T have two USB ports located on front panel. One port is designated for host use and the other as a device port. A host USB port can be used to plug in devices such as a PC, while device ports can be used for attaching Flash Memory Key devices.



### Note

Currently the two USB ports are not enabled on the Supervisor Engine 32, Supervisor Engine 32 PISA, and Supervisor Engine 720-10GE. The 5-pin USB port on the Supervisor Engine 2T is enabled. The second USB connector is not currently enabled.

## Copper and Fiber-Optic Connectors

This section describes the types of copper and fiber-optic connectors that are used with the supervisor engines.

### RJ-45 Connector

The RJ-45 connector (see [Figure B-2](#)) is used to connect a Category 3, Category 5, Category 5e, Category 6, or Category 6a FTP or UTP cable from the modem or terminal to the supervisor engine console port, or the network to a copper uplink port if the uplink port has a 1000BASE-T copper transceiver installed in it.

**Caution**

Category 5e, Category 6, and Category 6a cables can store high levels of static electricity because of the dielectric properties of the materials used in their construction. Always ground the cables (especially in new cable runs) to a suitable and safe earth ground before connecting them to the module.

**Caution**

To comply with GR-1089 intrabuilding, lightning-immunity requirements, you must use foil-twisted pair (FTP) cable that is properly grounded at both ends.

**Figure B-2 RJ-45 Interface Cable Connector**

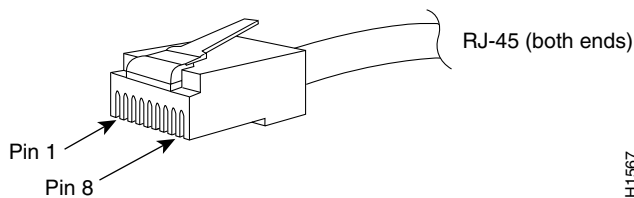

## Fiber-Optic Connectors

This section describes the SC and LC fiber-optic connectors used by the optical transceivers.

### SC Connectors

**Warning**

**Invisible laser radiation may be emitted from disconnected fibers or connectors. Do not stare into beams or view directly with optical instruments.** Statement 1051

The SC connector is used to connect fiber-optic module ports with the external network. (See [Figure B-3](#).)

**Figure B-3 SC Optical Connector**

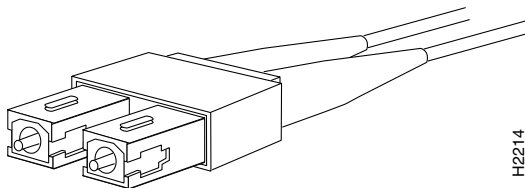

Always make sure that you insert the connector completely into the socket. This action is especially important when you are making a connection between a module and a long distance (1.24 miles [2 kilometers]) or a suspected highly attenuated network. If the link LED does not light, try removing the network cable plug and reinserting it firmly into the module socket. It is possible that enough dirt or skin oils have accumulated on the plug faceplate (around the optical-fiber openings) to generate significant attenuation, reducing the optical power levels below threshold levels so that a link cannot be made.

**Caution**

Use extreme care when removing or installing connectors so that you do not damage the connector housing or scratch the end-face surface of the fiber. Always install protective covers on unused or disconnected components to prevent contamination. Always clean fiber connectors before installing them.

When you disconnect the fiber-optic cable from the module, grip the body of the connector. Do not grip the connector jacket-sleeve. Gripping the sleeve can, over time, compromise the integrity of the fiber-optic cable termination in the SC connector.

## LC Connectors

Small form-factor pluggable (SFP) transceiver modules used on the Supervisor Engine 720 and Supervisor Engine 2T uplink ports use LC connectors shown in [Figure B-4](#).

**Figure B-4** LC Fiber-Optic Connector

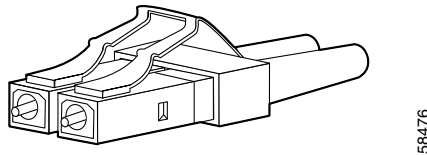
**Caution**

Use extreme care when removing or installing connectors so that you do not damage the connector housing or scratch the end-face surface of the fiber. Always install protective covers on unused or disconnected components to prevent contamination. Always clean fiber connectors before installing them.

When you disconnect the fiber-optic cable from the module, grip the body of the connector. Do not grip the connector jacket-sleeve. Gripping the sleeve can, over time, compromise the integrity of the fiber-optic cable termination in the LC connector.

**Warning**

**Invisible laser radiation may be emitted from disconnected fibers or connectors. Do not stare into beams or view directly with optical instruments.** Statement 1051, follow these steps:





## APPENDIX **C**

# ESD Precautions

---

Revised July 2011

This appendix provides information on preventing ESD when removing and installing supervisor engines in a chassis.

## Attaching Your ESD Grounding Strap

Electrostatic discharge (ESD) damage, which can occur when modules or other FRUs are improperly handled, results in intermittent or complete failures. Supervisor engines consist of printed circuit boards that are supported by metal carriers. Electromagnetic interference (EMI) shielding and connectors are integral components of the carrier. Although the metal carrier helps to protect the board from ESD, always use an ESD grounding strap when handling supervisor engines.

For preventing ESD damage, follow these guidelines:

- Always use an ESD wrist strap and ensure that it makes maximum contact with bare skin. ESD grounding straps are available with banana plugs, metal spring clips, or alligator clips. All Catalyst 6500 series chassis are equipped with a banana plug connector (identified by the ground symbol next to the connector) somewhere on the front panel.
  - If you have an older Catalyst 6500 series chassis equipped with a plastic banana plug connector, we recommend that you use either the supplied ESD grounding wrist strap (with a metal clip) or an ESD grounding wrist strap equipped with an alligator clip.
  - If you have a newer Catalyst 6500 series chassis that has a bare metal hole as the banana plug connector (also identified by the ground symbol next to the connector), we recommend that you use a personal ESD grounding strap equipped with a banana plug.
- If you choose to use the disposable ESD wrist strap supplied with most FRUs or an ESD wrist strap equipped with an alligator clip, you must attach the system ground lug to the chassis in order to provide a proper grounding point for the ESD wrist strap.



---

**Note** This system ground is also referred to as the network equipment building system (NEBS) ground.

---

- If your chassis does not have the system ground attached, you must install the system ground lug. Refer to the online *Catalyst 6500 Series Switches Installation Guide* for the procedure.



---

**Note** You do not need to attach a supplemental system ground wire to the system ground lug; the lug provides a direct path to the bare metal of the chassis

---

After you install the system ground lug, follow these steps to correctly attach the ESD wrist strap:

---

**Step 1** Attach the ESD wrist strap to bare skin as follows:

- a. If you are using the ESD wrist strap supplied with the FRUs, open the wrist strap package and unwrap the ESD wrist strap. Place the black conductive loop over your wrist and tighten the strap so that it makes good contact with your bare skin.
- b. If you are using an ESD wrist strap equipped with an alligator clip, open the package and remove the ESD wrist strap. Locate the end of the wrist strap that attaches to your body and secure it to your bare skin.

**Step 2** Grasp the spring or alligator clip on the ESD wrist strap and momentarily touch the clip to a bare metal spot (unpainted surface) on the rack.

We recommend that you touch the clip to an unpainted rack rail so that any built-up static charge is then safely dissipated to the entire rack.

**Step 3** Attach either the spring clip or the alligator clip to the ground lug screw as follows (See [Figure C-1](#)):

- a. If you are using the ESD wrist strap that is supplied with the FRUs, squeeze the spring clip jaws open, position the spring clip to one side of the system ground lug screw head, and slide the spring clip over the lug screw head so that the spring clip jaws close behind the lug screw head.



---

**Note** The spring clip jaws do not open wide enough to fit directly over the head of the lug screw or the lug barrel.

---

- b. If you are using an ESD wrist strap that is equipped with an alligator clip, attach the alligator clip directly over the head of the system ground lug screw or to the system ground lug barrel.



**Figure C-1 Attaching the ESD Wrist Strap Clip to the System Ground Lug Screw**

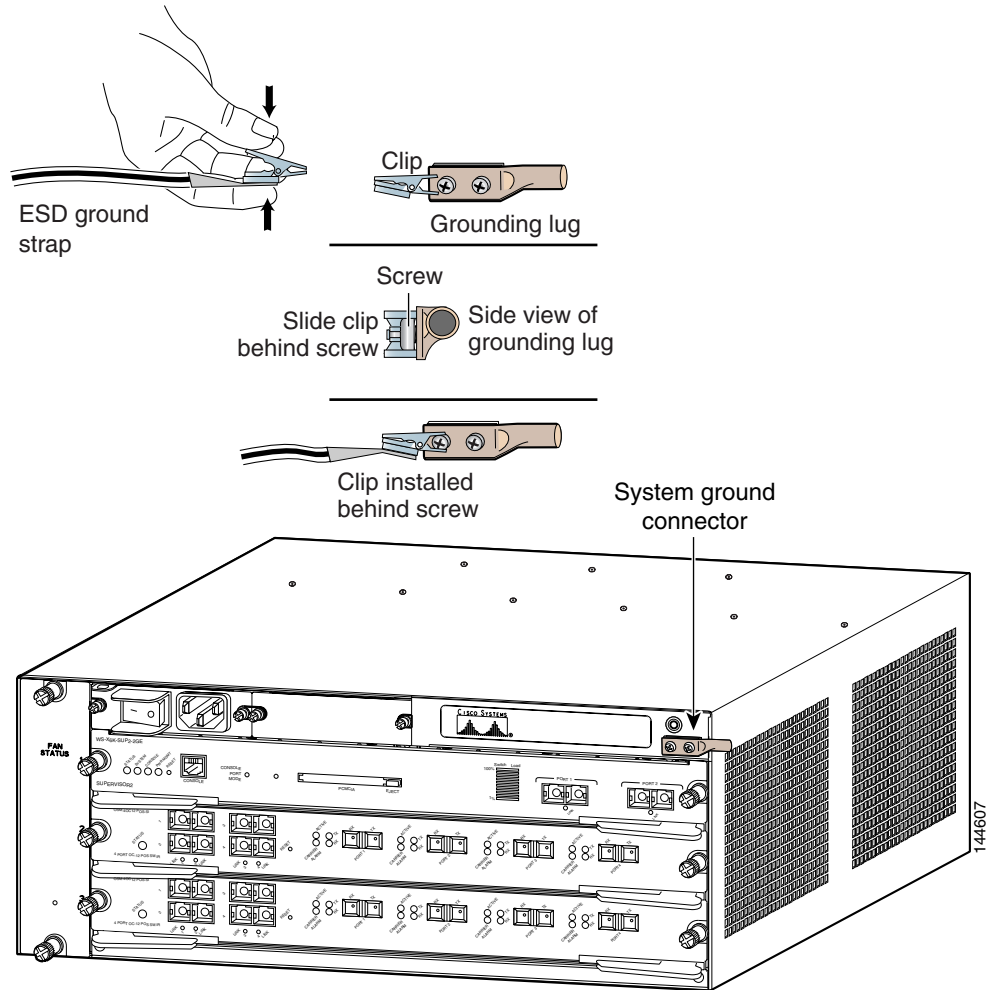

In addition, follow these guidelines when handling modules:

- Handle carriers by available handles or edges only; avoid touching the printed circuit boards or connectors.
- Place a removed component board-side-up on an antistatic surface or in a static-shielding container. If you plan to return the component to the factory, immediately place it in a static-shielding container.
- Never attempt to remove the printed circuit board from the metal carrier.



**Caution**

For safety, periodically check the resistance value of the antistatic strap. The measurement should be between 1 and 10 megohm (Mohm).

■ Attaching Your ESD Grounding Strap



## INDEX

---

### A

- accessory kit, console port [B-1](#)
- adapters
  - DB-25 [B-4](#)
  - DB-9 [B-3](#)
  - modem [B-4](#)
- audience [v](#)

---

### C

- cables
  - specifications [B-1](#)
- cabling
  - console ports [B-1](#)
- category 5e static electricity caution [B-8](#)
- category 6 static electricity caution [B-8](#)
- connectors
  - fiber optic [A-2](#)
  - see specific types of connectors (for example, MT-RJ connectors)
- console port
  - port mode switch [B-2](#)
  - signaling and pinouts
    - mode 1 [B-3](#)
    - mode 2 [B-5](#)
- console port mode switch
  - pinouts for mode 1 DB-25 adapters [B-4](#)
  - pinouts for mode 1 DB-9 adapters [B-3](#)
  - signaling for mode 1 [B-2](#)
  - signaling for mode 2 [B-2](#)
- conventions [vi](#)

---

### D

- DB-25 adapters
  - modem adapter pinout (table) [B-4](#)
  - pinouts (table) [B-4](#)
- DB-9 adapters
  - pinouts (table) [B-3](#)

---

### E

- ESD ground strap
  - attaching clip (figure) [C-3](#)
- ESD guidelines [C-1](#)

---

### I

- installation
  - starting the terminal emulation software [3-13](#)
- installation procedures
  - slot restrictions [3-2](#)
- installation tools [3-2](#)
- installing an ESD wrist strap [C-2](#)
- installing a supervisor engine [3-2](#)

---

### M

- mode-conditioning patch cord
  - description [3-18](#)
  - figure [3-21](#)
- modem adapter [B-4](#)

**N**

## network cables

- installing [3-17](#)
- uplink ports [3-18](#)

**P**

## PCMCIA

See also Flash PC cards

## pluggable transceivers

See specific transceiver type

## port mode switch

- mode 1 [B-3](#)
- mode 2 [B-5](#)
- use of [B-2](#)

**R**Regulatory Compliance and Safety Information [vii](#)related documentation [xiii](#)

## RJ-45 connectors

- description [B-7](#)
- figure [B-8](#)

rollover cable [B-2](#)**S**

## SC connector

- description [B-8](#)

## Supervisor Engine 2

- chassis compatibility [2-2](#)
- console port [2-3](#)
- description [2-1, 2-2](#)
- dimensions [2-4](#)
- fan tray requirements [2-2](#)
- front panel features (figure) [2-2](#)
- LED descriptions (table) [2-5](#)

memory [2-3](#)

MSFC support [2-4](#)

operating altitude [2-4](#)

operating temperature [2-4](#)

PFC support [2-4](#)

physical and environmental specifications (table) [2-4](#)

power requirements [2-4](#)

reset switch [2-3](#)

slot restrictions [2-2](#)

transceivers supported [2-4](#)

uplink port queue structure [2-3](#)

versions (table) [2-1](#)

weight [2-4](#)

WS-S2U-MSFC2 [2-2](#)

WS-X6K-MSFC2 [2-2](#)

WS-X6K-S2-PFC2 [2-1](#)

## Supervisor Engine 2T

console port [2-35](#)

description [2-33](#)

fan requirements [2-34](#)

front panel (figure) [2-33](#)

front panel features [2-35](#)

front panel LEDs (table) [2-38](#)

memory [2-35](#)

MSFC daughter card [2-36](#)

operating altitude [2-37](#)

operating temperature [2-37](#)

PFC daughter cards [2-36](#)

physical and environmental specifications (table) [2-37](#)

pluggable transceivers [2-36](#)

slot restrictions [2-34](#)

uplink ports [2-35](#)

USB ports [2-35](#)

## Supervisor Engine 32

buffer size [2-11](#)

chassis compatibility [2-8](#)

console port [2-10](#)

dimensions [2-12](#)

- fan tray requirements [2-8](#)
- front panel (figure) [2-7, 2-8](#)
- hardware restrictions [2-9](#)
- memory [2-10](#)
- model descriptions (table) [2-7](#)
- MSFC support [2-11](#)
- operating altitude [2-12](#)
- operating temperature [2-12](#)
- PFC support [2-11](#)
- physical and environmental specifications (table) [2-12](#)
- power requirement [2-12](#)
- reset switch [2-10](#)
- slot restrictions [2-8](#)
- transceivers supported [2-11](#)
- types [2-7](#)
- uplink port queue structure [2-11](#)
- uplink ports [2-11](#)
- weight [2-12](#)
- WS-SUP32-10GE-3B description [2-7](#)
- WS-SUP32-10GE-3B front panel features (figure) [2-8](#)
- WS-SUP32-GE-3B description [2-7](#)
- WS-SUP32-GE-3B front panel features (figure) [2-7](#)
- Supervisor Engine 32 PISA
  - buffer size [2-18](#)
  - chassis compatibility [2-15](#)
  - console port [2-17](#)
  - dimensions [2-19](#)
  - fan tray requirements [2-15](#)
  - front panel (figure) [2-14, 2-15](#)
  - hardware restrictions [2-16](#)
  - memory [2-17](#)
  - model descriptions (table) [2-14](#)
  - operating altitude [2-19](#)
  - operating temperature [2-19](#)
  - PFC support [2-18](#)
  - physical and environmental specifications (table) [2-19](#)
  - power requirement [2-19](#)
- reset switch [2-17](#)
- slot restrictions [2-15](#)
- transceivers supported [2-18](#)
- types [2-14](#)
- uplink port queue structure [2-18](#)
- uplink ports [2-18](#)
- weight [2-19](#)
- WS-SUP32P-10GE description [2-14](#)
- WS-SUP32P-10GE front panel features (figure) [2-15](#)
- WS-SUP32P-GE
  - description [2-14](#)
- WS-SUP32P-GE front panel features (figure) [2-14](#)
- Supervisor Engine 720
  - chassis compatibility [2-22](#)
  - console port [2-23](#)
  - description [2-21](#)
  - dimensions [2-24](#)
  - features (table) [2-22](#)
  - front panel (figure) [2-21](#)
  - front panel features [2-23](#)
  - front panel LEDs (table) [2-25](#)
  - memory [2-22](#)
  - MSFC daughter card [2-24](#)
  - operating altitude [2-24](#)
  - operating temperature [2-24](#)
  - PFC daughter cards supported [2-24](#)
  - physical and environmental specifications (table) [2-24](#)
  - power requirement [2-24](#)
  - reset button [2-23](#)
  - slot restrictions [2-22](#)
  - transceivers supported [2-24](#)
  - uplink ports [2-23](#)
  - versions (table) [2-21](#)
- Supervisor Engine 720-10GE
  - console port [2-28](#)
  - description [2-26](#)
  - features (table) [2-27, 2-34](#)
  - front panel (figure) [2-26](#)

- front panel features [2-28](#)
- front panel LEDs (table) [2-31](#)
- memory [2-28](#)
- models [2-26](#), [2-33](#)
- MSFC daughter card [2-29](#)
- operating altitude [2-30](#)
- operating temperature [2-30](#)
- PFC daughter cards [2-29](#)
- physical and environmental specifications (table) [2-30](#)
- pluggable transceivers [2-29](#)
- slot restrictions [2-27](#)
- uplink ports [2-28](#)
- USB ports [2-28](#)
- supervisor engine installation procedure [3-2](#)
- supervisor engines
  - handling guidelines [C-3](#)

---

## T

- tools
  - required for installation [3-2](#)
- transceivers
  - See specific transceiver type

---

## W

- warnings
  - translations [vii](#)